



SPECIFICATIONS

DISPLAY

Liquid crystal display with backlight
1 line, 4 digits and 2 line, 7 digits per line to show electrical Parameters

LCD INDICATIONS

MD - Maximum Demand of Power
 - Communication in progress

LED INDICATIONS

INT - Integration of energy

WIRING INPUT

3 Ø - 4 wire, 1 Ø - 2 wire

RATED INPUT VOLTAGE

60 to 300V AC (L-N);
104 to 520V AC (L-L)

FREQUENCY RANGE

45-65 Hz

NO OF CHANNEL

3 Ø - 2 Channel, 1 Ø - 6 Channel (Selectable)

CT PRIMARY L1 and CT PRIMARY L2

5A to 10,000A (Programmable for any Value)

CT SECONDARY

333mV

PTPRIMARY

100V to 10kV (Programmable for any value)

PT SECONDARY

100 to 500V AC (L-L)(Programmable for any value)

DISPLAY UPDATE TIME

1sec for all parameters

POWER CONSUMPTION

Less than 8VA

ENVIRONMENTAL CONDITIONS

- Indoor use
- Altitude of up to 2000 meters
- Pollution degree II

Temperature : Operating : -10°C to 55°C

Storage : -20°C to 75°C

Humidity : Up to 85% non-condensing

MOUNTING : Din Rail mounting

WEIGHT : 200gms.

OUTPUT :

Pulse Output : Voltage range : 5 - 27V DC
Current capacity : 100mA max.

Pulse Duration : Selectable between 0.1 to 2.0sec.

Pulse Weight : Selectable between 0.01 to 9.99kWh

NOTE : In 6 channel the pulse output will act as a totalizer of 3 channels.

Pulse Output 1 -Totalizer of Ch1, Ch2, Ch3

Pulse Output 2- Totalizer of Ch4, Ch5, Ch6

ORDER CODE INFORMATION		
Product	Supply	Certification
	Self Supplied(V1,N)	CE
METSEEMD461R	60 to 300V AC, 50 / 60Hz, (±5%)	■
Installation Category III		

SERIAL COMMUNICATION	
Interface standard and protocol	RS485 AND MODBUS RTU
Communication address	1 to 255
Transmission mode	Half duplex
Data types	Float and Integer
Transmission distance	500 Metre maximum
Transmission speed	300, 600,1200, 2400, 4800, 9600,19200 (in bps)
Parity	None, Odd, Even
Stop bits	1 or 2

RESOLUTION		
PT Ratio x CT Ratio	kWh	INT
<15	0.01K	0.001K
<150	0.1K	0.01K
<1500	1K	0.1K
<15000	0.01M	1K
<150000	0.1M	0.01M

NOTE : 1) For Voltage, Current, Power, resolution is automatically adjusted
 2) For power factor, resolution is 0.01
 3) Total energy is highest resolution of loads

ACCURACY :	
Measurement	Accuracy
Voltage V_{LN}	±0.5% of full Range
Voltage V_{LL}	±0.5% of full Range
Current	±0.5% of full Range
Frequency For L-N Voltage >20V, For L-L Voltage >35V	±0.1% of full Range
Active Power	±1% of full Range
Apparent power	±1% of full Range
Reactive Power	±1% of full Range
Power factor	±0.01 of full Range
Active Energy Class 1 (A)	IEC62053-21, EN50470-1/-3
Reactive energy Class 2	IEC62053-22
MAXActive Power	±1% of full Range
MAXApparent Power	±1% of full Range

SAFETY PRECAUTIONS

All safety related codifications, symbols and instructions that appear in this operating manual or on the equipment must be strictly followed to ensure the safety of the operating personnel as well as the instrument.

If the equipment is not used in a manner specified by the manufacturer it might impair the protection provided by the equipment.

- Do not use the equipment if there is any mechanical damage.
- Ensure that the equipment is supplied with correct voltage.

CAUTION :

1. Read complete instructions prior to installation and operation of the unit.
2. Risk of electric shock.
3. The equipment in its installed state must not come in close proximity to any heating sources, oils, steam, caustic vapors or other unwanted process by products.

WIRING GUIDELINES

WARNING :

1. To prevent the risk of electric shock, power supply to the equipment must be kept OFF while doing the wiring arrangement.
2. Wiring shall be done strictly according to the terminal layout. Confirm that all connections are correct.
3. Use lugged terminals.
4. To reduce electromagnetic interference use of wires with adequate ratings and twists of the same in equal size shall be made with shortest connections.
5. Layout of connecting cables shall be away from any internal EMI source.
6. Cable used for connection to power source, must have a cross section of 0.5mm² to 2.5mm² (20 to 14AWG ; 75°C (min)).
7. Copper cable should be used (Stranded or Single core cable).
8. Before attempting work on device, ensure absence of voltages using appropriate voltage detection device.

INSTALLATION GUIDELINES

CAUTION :

1. This equipment, being built-in-type, normally becomes a part of main control panel and in such case the terminals do not remain accessible to the end user after installation and internal wiring.
2. Conductors must not come in contact with the internal circuitry of the equipment or else it may lead to a safety hazard that may in turn endanger life or cause electrical shock to the operator.
3. Circuit breaker or mains switch must be installed between power source and supply terminals to facilitate power 'ON' or 'OFF' function. However this switch or breaker must be installed in a convenient position normally accessible to the operator.
4. The equipment shall not be installed in environmental conditions other than those mentioned in this manual.
5. The equipment does not have a built-in-type fuse. Installation of external fuse of rating 275V AC / 0.5Amp for electrical circuitry / battery is highly recommended.

DIMENSIONS (All dimensions in mm)

Front View

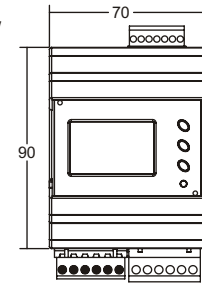

Side View

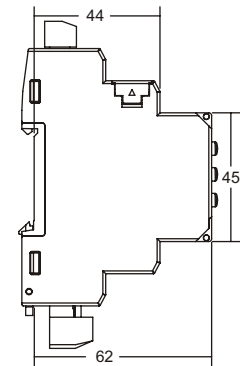

TERMINAL CONNECTIONS

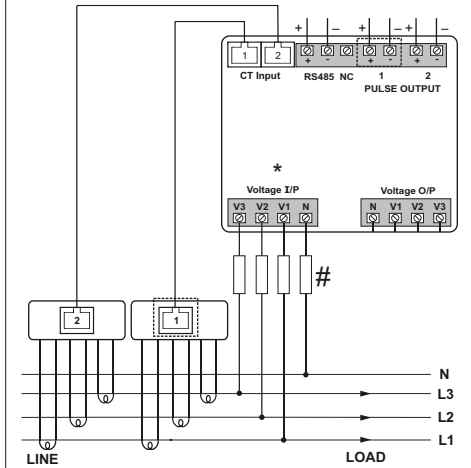

*NOTE : L1 needs to be included even if L2, or L3 are used for reference (6 channel & single phase)



All fuse types : 0.5A class CC UL type
0.5A fast acting 600V

CHANNEL DESCRIPTION		
LOAD	2 CH	6 CH
L1	1st, 2nd & 3rd phase of current 1	CH1, CH2, CH3
L2	1st, 2nd & 3rd phase of current 2	CH4, CH5, CH6

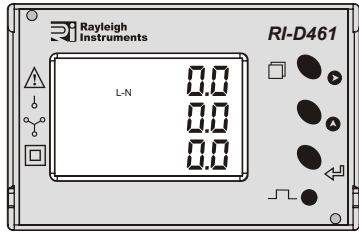













FRONT PANEL DESCRIPTION













ONLINE PAGE DESCRIPTION













There are 2 dedicated key labeled as PAGE and PRG with symbols marked as  and  to read meter parameters.









At power ON meter displays average phase to neutral voltage and active energy of three phases. If any key is not pressed for 60sec., unit resumes manual mode.

KEY PRESS	PARAMETER KEY	DESCRIPTION
ONLINE PAGE DESCRIPTION FOR 2CH		
Press page (P) key (1st time)	—	Displays line to neutral voltage of three phases
	Press  key	Displays line to line voltage of three phases
	Press  key 3 sec.	Displays voltage sequence.
Press page (P) key (2nd time)	—	Displays current of three phases of load 1.
	Press  key	Displays current of three phases of load 2.
Press page (P) key (3rd time)	—	Displays power factor of three phases of load 1 and frequency.
	Press  key 1st time	Displays power factor of three phases of load 2 and frequency.
	Press  key 2nd time	Displays active power of three phases of load 1.
	Press  key 3rd time	Displays active power of three phases of load 2.
	Press  key 4th time	Displays reactive power of three phases of load 1.
	Press  key 5th time	Displays reactive power of three phases of load 2.
	Press  key 6th time	Displays apparent power of three phases of load 1.
	Press  key 7th time	Displays apparent power of three phases of load 2.
	Press  key 8th time	Displays total active power of three phases of load 1 and load 2.
	Press  key 9th time	Displays total reactive power of three phases of load 1 and load 2.
	Press  key 10th time	Displays total apparent power of three phases of load 1 and load 2.
	Press  key 11th time	Displays max demand of active power of load 1 and load 2
Press  key 12th time	Displays max demand of apparent power of load 1 and load 2	

KEY PRESS	PARAMETER KEY	DESCRIPTION
ONLINE PAGE DESCRIPTION FOR 2CH		
Press page (P) key (4th time)	—	Displays average phase to neutral voltage and active energy of three phases of load 1 and load 2
	Press  key 1st time	Displays average phase to neutral voltage and reactive energy of three phases of load 1 and load 2
	Press  key 2nd time	Displays total active energy of three phases of Load 1 and Load 2
	Press  key 3rd time	Displays total reactive energy of three phases of Load 1 and Load 2
Note - For 1 phase 2 wire network, all page will be same as 3 phase 4 wire, but only selected phase parameter will display.		

KEY PRESS	PARAMETER KEY	DESCRIPTION
ONLINE PAGE DESCRIPTION FOR 6CH		
Press page (P) key (1st time)	—	Displays line to neutral voltage of selected phase.
Press page (P) key (2nd time)	—	Display current of CH 1 on 1st row, CH 2 on 2nd row and CH 3 on 3rd row as page one.
	Press  key 1st time	Display current of CH 4 on 1st row, CH 5 on 2nd row and CH 6 on 3rd row as page two.
Press page (P) key (3rd time)	—	Display power factor of CH 1 on 1st row, CH 2 on 2nd row and CH 3 on 3rd row as page one & Frequency
	Press  key 1st time	Display power factor of CH 4 on 1st row, CH 5 on 2nd row and CH 6 on 3rd row as page Two & Frequency
	Press  key 1st time	Display power factor of CH 4 on 1st row, CH 5 on 2nd row and CH 6 on 3rd row as page one.
	Press  key 2nd time	Display active power of CH 1 on 1st row, CH 2 on 2nd row and CH 3 on 3rd row as page one.
	Press  key 3rd time	Display active power of CH 4 on 1st row, CH 5 on 2nd row and CH 6 on 3rd row as page two.
	Press  key 4th time	Display reactive power of CH 1 on 1st row, CH 2 on 2nd row and CH 3 on 3rd row as page one.
	Press  key 5th time	Display reactive power of CH 4 on 1st row, CH 5 on 2nd row and CH 6 on 3rd row as page two.
	Press  key 6th time	Display apparent power of CH 1 on 1st row, CH 2 on 2nd row and CH 3 on 3rd row as page one.

KEY PRESS	PARAMETER KEY	DESCRIPTION
ONLINE PAGE DESCRIPTION FOR 6CH		
Press page (P) key (3rd time)	Press  key 7th time	Display apparent power of CH 4 on 1st row, CH 5 on 2nd row and CH 6 on 3rd row as page two.
	Press  key 8th time	Displays total active power of load 1 (CH1,CH2,CH3) on 1st row and load 2 (CH4,CH5,CH6) .
	Press  key 9th time	Displays total reactive power of load 1 (CH1,CH2,CH3) on 1st row and load 2 (CH4,CH5,CH6) .
	Press  key 10th time	Displays total apparent power of load 1 (CH1,CH2,CH3) on 1st row and load 2 (CH4,CH5,CH6) .
	Press  key 11th time	Displays max demand of active power of CH 1 on 1st row, CH 2 on 2nd row and CH 3 on 3rd row as page one.
	Press  key 12th time	Displays max demand of apparent power of CH 1 on 1st row, CH 2 on 2nd row and CH 3 on 3rd row as page one.
Press page (P) key (3rd time)	Press  key 13th time	Displays max demand of active power of CH 4 on 1st row, CH 5 on 2nd row and CH 6 on 3rd row as page two.
	Press  key 14th time	Displays max demand of apparent power of CH 4 on 1st row, CH 5 on 2nd row and CH 6 on 3rd row as page two.
	—	Displays line to neutral voltage of selected phase on 1st row and CH1 active energy
Press page (P) key (4th time)	Press  key 1st time	Displays line to neutral voltage of selected phase on 1st row and CH1 reactive energy
	Press  key 2nd time	Displays line to neutral voltage of selected phase on 1st row and CH2 active energy
	Press  key 3rd time	Displays line to neutral voltage of selected phase on 1st row and CH2 reactive energy
	Press  key 4th time	Displays line to neutral voltage of selected phase on 1st row and CH3 active energy
	Press  key 5th time	Displays line to neutral voltage of selected phase on 1st row and CH3 reactive energy

KEY PRESS	PARAMETER KEY	DESCRIPTION
ONLINE PAGE DESCRIPTION FOR 6CH		
Press page (P) key (4th time)	Press  key 6th time	Displays line to neutral voltage of selected phase on 1st row and CH4 active energy
	Press  key 7th time	Displays line to neutral voltage of selected phase on 1st row and CH4 reactive energy
	Press  key 8th time	Displays line to neutral voltage of selected phase on 1st row and CH5 active energy
	Press  key 9th time	Displays line to neutral voltage of selected phase on 1st row and CH5 reactive energy
	Press  key 10th time	Displays line to neutral voltage of selected phase on 1st row and CH6 active energy
Press page (P) key (4th time)	Press  key 11th time	Displays line to neutral voltage of selected phase on 1st row and CH6 reactive energy.
	Press  key 12th time	Displays line to neutral voltage of selected phase on 1st row and total active energy of all channel.
	Press  key 13th time	Displays line to neutral voltage of selected phase on 1st row and total reactive energy of all channel.
Note : All pages will be same as above for P1/P2/P3 only phase wise voltage will be displayed		

SERIAL NUMBER DESCRIPTION

Press ▲ key for 10sec. to display 8 digit serial number, the serial number will be displayed for 10 second

CONFIGURATION

There are 3 dedicated key with symbols marked as and . Use these 3 key to enter into configuration / change setting.

Note : The settings should be done by a professional, after going through this users manual and after having understood the application situation.

For the configuration setting mode :

- Use and for 3sec. to enter or exit from config. mode.
- Use shift key to move cursor left or right by one digit each time. After last digit of display cursor shift at 1st digit of display.
- Use increment key for increasing the parameter value.
- Use key to save the setting and move on to next page.
- Use and keys to go back and to previous page.

Config. page.	Function	Range or Selection	Factory Setting
	Password	0000 to 9998	1000
1	Change Password	No / Yes	No
1.1	New Password	0000 to 9998	1000
2	Channel Selection	2CH / 6CH	2CH
3	Network Selection	3P4W, 1P2W-P1, 1P2W-P2, 1P2W-P3.	3P4W
4	CT Secondary	Preset	5
5	CT Primary 1	5A to 10,000A	160
6	CT Primary 2	5A to 10,000A	160
7	PT Secondary	100V to 500V	350
8	PT primary	100V to 10kV	350
9	Slave Id	1 to 255	1
10	Baud Rate	300, 600, 1200, 2400, 4800, 9600 and 19200	9600
11	Parity	None, Even, Odd	None
12	Stop Bit	1 or 2	1
13	Back Light	0 to 7200 sec.	0000
14	Demand interval method	Sliding / Fixed	Sliding
15	Demand interval duration	1 to 30	15
16	Demand interval length	1 to 30min	1
17 *	Pulse Weight (load 1)	0.01 to 9.99kWh	0.10
18 *	Pulse Weight (load 2)	0.01 to 9.99kWh	0.10
19 *	Pulse Duration	0.1 to 2.0 sec.	0.1
20	Factory Default	No / Yes	No
21	Reset Energy and Max Demand	No / Yes	No
•21.1	Password	0001 to 9999	1001
21.01	Reset Active Energy	No / Yes	No
21.02	Reset Reactive Energy	No / Yes	No

Config. page.	Function	Range or Selection	Factory Setting
21.03	Reset Max Power	No / Yes	No
•21.1	Password	0001 to 9999	1001
21.01	Reset Active Energy -1	No / Yes	No
21.02	Reset Reactive Energy -1	No / Yes	No
21.03	Reset L1 Max Power	No / Yes	No
21.04	Reset Active Energy -2	No / Yes	No
21.05	Reset Reactive Energy -2	No / Yes	No
21.06	Reset L2 Max Power	No / Yes	No

• For resetting energy parameters user will be prompted the password. If correct password is entered, the user will be able to reset all energy parameters. This password will be value which will be greater than the configuration password by 1.

* In RI-D460 valid only for 2 channel selection

LEFT HAND CT MOUNTING PHASE CORRECTION

The meter phases L1, L2 & L3 are setup as default for the CT to be mounted as an incomer or on the RH side of the board.

Meter display shows rH when is pressed for 3 sec. When the CT is mounted on the LH side of the board the phase sequence needs to be reversed.

- Press for seconds, then release and then press again for 3 sec. Phase will be reversed and display will show LH
- Wait 5 sec. for meter to resume online reading. Meter display shows LH when is pressed for 3 sec.

MODBUS REGISTER ADDRESSES LIST

Readable / writable parameters						
Address	Hex Address	Parameter	Range		Length (Register)	Data Structure
			Min value	Max value		
40000	0x00	Password	0	9998	1	Integer
			Value	Meaning		
40001	0x01	N/W selection	0x0000	3P-4W	1	Integer
			0x0002	1P2W-P1	1	Integer
			0x0003	1P2W-P2	1	Integer
			0x0004	1P2W-P3	1	Integer
			Min value	Max value		
40002	0x02	CT Secondary (A)	5	5	1	Integer
•40003	0x03	CT primary L1 (A) [load 1]	5	10000	1	Integer
40004	0x04	PT Secondary (V)	100	500	1	Integer
40005	0x05	PT primary (V)	100	10000	2	Integer
40007	0x07	Slave id	1	255	1	Integer
			Value	Meaning		
40008	0x08	Baud rate (bps)	0x0000	300	1	Integer
			0x0001	600		
			0x0002	1200		
			0x0003	2400		
			0x0004	4800		
			0x0005	9600		
			0x0006	19200		
40009	0x09	Parity	0x0000	None	1	Integer
			0x0001	Odd		
			0x0002	Even		
40010	0x0A	Stop bit	0x0000	1	1	Integer
			0x0001	2		
			Min value	Max value		
40011	0x0B	Backlight OFF (sec.)	0	7200	1	Integer
			Value	Meaning		
40012	0x0C	Factory Default	1	Set to factory setting range	1	Integer
40013	0x0D	Reset kWh Of load 1	1	Reset Total Active Energy	1	Integer
40015	0x0F	Reset kVArh Of load 1	1	Reset Total Reactive Energy	1	Integer
40034	0x22	Demand Interval Method	0X0000	Sliding	1	Integer
			0X0001	Fixed		
40035	0x23	Demand Interval Duration	MIN Value : 1	MAX Value : 30	1	Integer
40036	0x24	Demand Interval Length(min)	MIN Value : 1	MAX Value : 30	1	Integer
40037	0x25	Reset max kW Of load 1		Reset max Active power	1	Integer
40041	0x29	Reset max kVA Of load 1		Reset max Apparent power	1	Integer
40042	0x2A	Reset kWh Of load 2		Reset Total Active energy	1	Integer
40044	0x2B	Reset kVArh Of load 2		Reset Total Reactive energy	1	Integer
40045	0x2C	Reset max kW Of load 2		Reset max Active power	1	Integer
40049	0x31	Reset max kVA Of load 2		Reset max Apparent power	1	Integer
			Min value	Max value		
40050	0x32	CT primary L2 (A) load 2	5	10000	1	Integer
40057	0x39	Pulse Duration (sec.)	0.1	2.0 (sec.)	1	Integer
40058	0x3A	Pulse Weight of load 1 (kWh)	0.01	9.99 (kWh)	1	Integer
40059	0x3B	Pulse Weight (kWh) Of load 2	0.01	9.99 (kWh)	1	Integer
			Value	Meaning		
40060	0x3C	No of Channel	0	2 CH	1	Integer
			1	6 CH	1	Integer

* 0.1 resolution [1 = 0.1sec.] # 0.01 resolution [1 = 0.01kWh]

MODBUS REGISTER ADDRESSES LIST

Readable parameters : [Length (Register) : 2 ; Data Structure : Float]

NOTE : In 4 byte data type, LSB will be displayed on lower address and MSB will be displayed on higher address.

Address	Hex Address	Parameter
30000	0x00	Voltage V1N
30002	0x02	Voltage V2N
30004	0x04	Voltage V3N
30006	0x06	Average Voltage LN
30008	0x08	Voltage V12
30010	0x0A	Voltage V23
30012	0x0C	Voltage V31
30014	0x0E	Average Voltage LL
30132	0x84	Serial No (Data Structure : Hex)
For Load 2 parameters		
30016	0x10	Current I1
30018	0x12	Current I2
30020	0x14	Current I3
30022	0x16	Average Current
30024	0x18	kW1
30026	0x1A	kW2
30028	0x1C	kW3
30030	0x1E	kVA1
30032	0x20	kVA2
30034	0x22	kVA3
30036	0x24	kVAr1
30038	0x26	kVAr2
30040	0x28	kVAr3
30042	0x2A	Total kW
30044	0x2C	Total kVA
30046	0x2E	Total kVAr
30048	0x30	PF1
30050	0x32	PF2
30052	0x34	PF3
30054	0x36	Average PF
30056	0x38	Frequency
30058	0x3A	kWh
30062	0x3E	kVArh
30064	0x40	kW MAX Active Power
30072	0x48	kVA MAX Apparent Power
30134	0x86	Existing kW MAX Active Power
30138	0x8A	Existing kVA MAX Apparent Power

Address	Hex Address	Only for Load 1 Parameter
30074	0x4A	Current I1
30076	0x4C	Current I2
30078	0x4E	Current I3
30080	0x50	Average Current
30082	0x52	kW1
30084	0x54	kW2
30086	0x56	kW3
30088	0x58	kVA1
30090	0x5A	kVA2
30092	0x5C	kVA3
30094	0x5E	kVAr1
30096	0x60	kVAr2
30098	0x62	kVAr3
30100	0x64	Total kW
30102	0x66	Total kVA
30104	0x68	Total kVAr
30106	0x6A	PF1
30108	0x6C	PF2
30110	0x6E	PF3
30112	0x70	Average PF
30114	0x72	Frequency
30116	0x74	kWh
30120	0x78	kVArh
30122	0x7A	kW MAX Active Power
30130	0x82	kVA MAX Apparent Power
30142	0x8E	Total kWh (Load 1 and Load 2)
30144	0x90	Total kVArh (Load 1 and Load 2)
30146	0x92	Existing kW MAX Active Power
30148	0x94	Existing kVA MAX Apperant Power
FOR 6 CHANNEL ONLY		
30150	0x96	kWh of CH1
30152	0x98	kWh of CH2
30154	0x9A	kWh of CH3
30156	0x9C	kWh of CH4
30158	0x9E	kWh of CH5
30160	0xA0	kWh of CH6
30162	0xA2	kVArh of CH1

Address	Hex Address	Parameter
30164	0xA4	kVArh of CH2
30166	0xA6	kVArh of CH3
30168	0xA8	kVArh of CH4
30170	0xAA	kVArh of CH5
30172	0xAC	kVArh of CH6
30174	0xAE	kW Max active power of CH1
30176	0xB0	kW Max active power of CH2
30178	0xB2	kW Max active power of CH3
30180	0xB4	kW Max active power of CH4
30182	0xB6	kW Max active power of CH5
30184	0xB8	kW Max active power of CH6
30186	0xBA	kVA Max apparent power of CH1
30188	0xBC	kVA Max apparent power of CH2
30190	0xBE	kVA Max apparent power of CH3
30192	0xC0	kVA Max apparent power of CH4
30194	0xC2	kVA Max apparent power of CH5
30196	0xC4	kVA Max apparent power of CH6
30198	0xC6	Existing kW Max active power of CH1
30200	0xC8	Existing kW Max active power of CH2
30202	0xCA	Existing kW Max active power of CH3
30204	0xCC	Existing kW Max active power of CH4
30206	0xCE	Existing kW Max active power of CH5
30208	0xD0	Existing kW Max active power of CH6
30210	0xD2	Existing kVA Max apparent power of CH1
30212	0xD4	Existing kVA Max apparent power of CH2
30214	0xD6	Existing kVA Max apparent power of CH3
30216	0xD8	Existing kVA Max apparent power of CH4
30218	0xDA	Existing kVA Max apparent power of CH5
30220	0xDC	Existing kVA Max apparent power of CH6

APPLICATION OF PULSE OUTPUT

PROCESS INTEGRATION

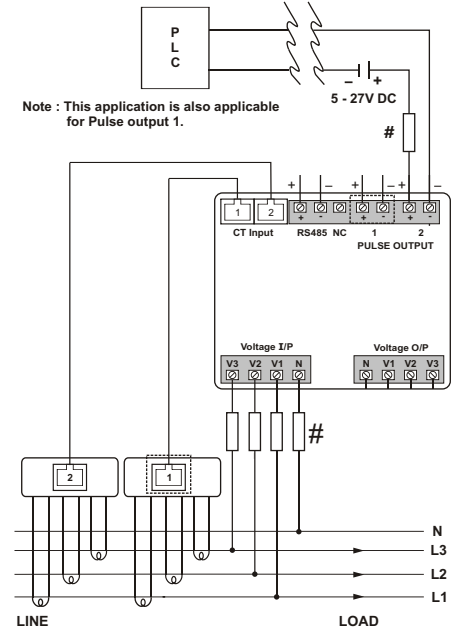

Pulse output from RI-D461 meter can be interfaced into a process through a PLC for on line control of energy content in the process. If the PLC has a self excited digital input, external DC supply is not needed. The kWh pulse is also used to derive average kWh information at the PLC.

All fuse types : 0.5A class CC UL type
0.5A fast acting 600V

(Specifications subject to change as development is a continuous process.)

Schneider Electric Australia
78 Waterloo Road,
Macquarie Park
NSW 2113
Tel: 13 SEAU (73 28)
Email: customercare.au@schneider-electric.com