

Installation and Quick Configuration

Environmental Manager Main Module

AP9340

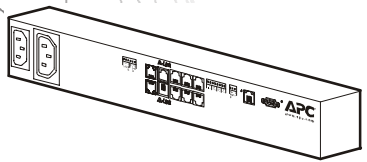



This manual is available in English on the enclosed CD.

Dieses Handbuch ist in Deutsch auf der beiliegenden CD-ROM verfügbar.

Este manual está disponible en español en el CD-ROM adjunto.

Ce manuel est disponible en français sur le CD-ROM ci-inclus.

Questo manuale è disponibile in italiano nel CD-ROM allegato.

本マニュアルの日本語版は同梱の CD-ROM からご覧になれます。

Instrukcja Obsługi w języku polskim jest dostępna na CD.

Данное руководство на русском языке имеется на прилагаемом компакт-диске.

O manual em Português está disponível no CD-ROM em anexo.

Bu kullanım kilavuzunun Türkçe'sä, äläxäkte gönderälen CD äçeräsände mevcuttur.

您可以从包含的 CD 上获得本手册的中文版本。

Contents

Installation	1
Preliminary Information	1
Overview	1
Inventory	1
Additional options	2
Additional documentation	2
Please recycle	2
Receiving inspection	2
InfraStruXure-certified	2
Front and Rear Panel Components	3
Front panel	3
Rear panel	3
Installation—Main Module	5
Toolless peg-mount installation	5
Rack-mount installation	5
Installation—TH Module	6
Connecting TH Modules	6
Adding power supplies	8
How to wire Modbus	9
Installation—Accessories	9
Sensors	9
Alarm beacon (optional)	13
User inputs (optional)	13
Quick Configuration.....	15
Overview	15
TCP/IP Configuration Methods	15
APC Device IP Configuration Wizard	16
.ini file utility	16
BOOTP & DHCP configuration	16
Local access to the control console	18
Remote access to the control console	18
Control console	19

Accessing a Configured Main Module	20
Overview	20
Web interface	20
Telnet and SSH	21
Simple Network Management Protocol (SNMP)	21
FTP and SCP	22
Modbus	22
Recovering from a Lost Password	23
Specifications	24
Environmental Manager Main Module	24
Sensors	25
Product Information	27
Two-Year Factory Warranty	27
Terms of warranty	27
Non-transferable warranty	27
Exclusions	27
Warranty claims	28
Life-Support Policy	28
General policy	28
Examples of life-support devices	29

Installation

Preliminary Information

Overview

Use the Environmental Manager Main Module to monitor and control the environment through peripheral devices, including temperature and humidity sensors and environmental control devices. You can increase the number of monitored racks by adding Temperature/Humidity Modules (TH Modules) to your configuration.

Inventory

Quantity	Item
1	Main Module (AP9340)
1	RS-232 configuration cable
2	Brackets for a standard 19-in rack
4	8-32 x 1/4-in Phillips-head screws
2	Toolless mounting pegs (pre-installed)
1	Temperature sensor (AP9335T)
1	Temperature/humidity sensor (AP9335TH)
1	1.8-m (6-ft) IEC 320-C13 to IEC 320-C14 power cord
1	1.8-m (6-ft) NEMA 5-15P to IEC-C13 power cord
2	A-Link terminators
10	Tie wraps
4	Adhesive cable mounts
1	Adhesive temperature sensor mount
1	Adhesive temperature/humidity sensor mount
2	Wall anchors
2	Flat-head screws

Additional options

The following options are available for the Main Module:

- TH Module (AP9341)
- Temperature Sensor (AP9335T)
- Temperature/Humidity Sensor (AP9335TH)
- Temperature Sensor with Digital Display (A-Link) (AP9520T)
- Temperature/Humidity Sensor with Digital Display (A-Link) (AP9520TH)
- Alarm Beacon (AP9324)
- Door Switch Kit (AP9513)
- Power Supply (AP9505i)

Additional documentation

For additional information about management interfaces, user accounts, customizing setup, configuration utilities, file transfers, and the Device IP Configuration Wizard, see the Environmental Manager: Main Module *User's Guide*, available on the supplied *Utility CD* or on the APC Web site: www.apc.com.

For additional security information, see the *Security Handbook*, available on the *Utility CD* or on the APC Web site: www.apc.com.

The Modbus register map is available on the APC Web site: www.apc.com.

Please recycle



The shipping materials are recyclable. Please save them for later use, or dispose of them appropriately.

Receiving inspection

Inspect the package and its contents for shipping damage and ensure that the parts included in the shipment match all of the parts listed in the inventory table on page 1. Immediately report any shipping damage to the shipping agent. Report missing contents, damage, or other problems to APC or your APC reseller.

InfraStruXure-certified

This product is certified for use in APC InfraStruXure systems. If you have InfraStruXure Manager as part of your system, the Quick Configuration instructions in this document do not apply. See the documentation included with your InfraStruXure Manager for more information.

Front and Rear Panel Components

Front panel

Use the toolless mounting pegs on the front panel of the Main Module to install it in an APC rack or enclosure without using any U-spaces.

Rear panel

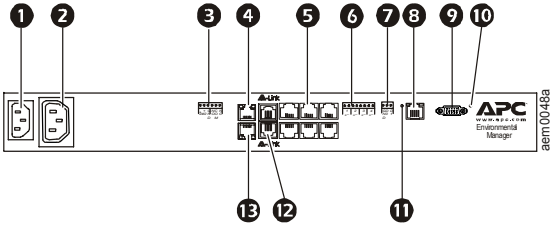

	Item	Description
1	AC Line Inlet	Provides power to the Main Module; see “Specifications” on page 24 for voltage information.
2	Switched Outlet	Provides power to a device at a total maximum amperage of 10 A. Activate a connected device when configured events are activated (e.g., turn on a fan when temperature rises above 23.9°C [75°F]).
3	Voltage Output	Provides 12 Vdc or 24 Vdc (75 mA) to a connected device.
	Relay Output	Connects to relay-controlled external devices.
4	Peripheral port	Connects to an optional device.
5	Sensor ports	Connect six temperature or temperature/humidity sensors (AP9335T or AP9335TH).
6	User Inputs	Connect four sensor devices. Supports the following: <ul style="list-style-type: none"> • Dry contacts • 0-5 V digital signals • 0-5 Vdc analog voltage • 4-20 mA current-loop sensors. See the Environmental Manager: Main Module <i>User’s Guide</i> , available on the included <i>Utility CD</i> or on the APC Web site (www.apc.com), for configuration information.
7	Modbus RS-485 port	Connect the Main Module to a building management system using the Modbus protocol.

	Item	Description
8	10/100 Base-T Network Port	<p>Connect the Main Module to the network; Status and Link LEDs indicate network traffic.</p> <ul style="list-style-type: none"> • Status LED—blinks orange and green at start-up; indicates the status of the network connection (solid green—IP address established; blinking green—attempting to obtain an IP address). • Link LED—blinks to indicate network traffic (green—operating at 10 mbps; orange—operating at 100 mbps).
9	RS-232 Console Port	Serial port used to configure initial network settings using the provided RS-232 configuration cable.
10	Reset switch	Resets the Main Module.
11	Power LED	Indicates whether the unit is receiving power (green—receiving power; dark—not receiving power).
12	A-Link ports	Expansion bus for adding APC TH Modules (AP9341), temperature sensors (AP9520T), and temperature/humidity sensors (AP9520TH). The bus provides communications and power to the TH Modules using standard CAT5 cabling with straight-through wiring.
13	Alarm beacon port	Connect an alarm beacon (AP9324).

Installation—Main Module

You can install the Main Module in the front or the rear of the rack or enclosure, using either the rack-mount option, which uses 1 U of rack space, or the toolless peg-mount option, which does not use any U-spaces. (The toolless peg-mount option is available only with APC NetShelter® VX and SX racks and enclosures).

Toolless peg-mount installation

1. Slide both mounting pegs into the holes located in the cable channel in the rear panel of the rack.
2. Snap the Main Module into place by pushing it downward until it locks into position.

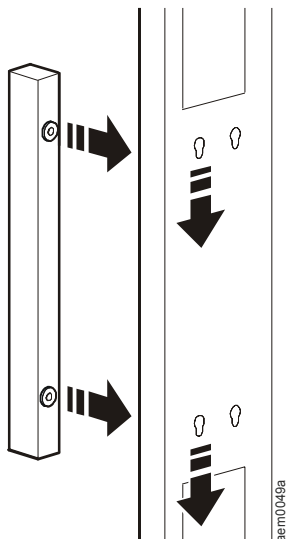

Rack-mount installation

1. Remove the toolless mounting pegs located at the front of the unit.
2. Attach the brackets (provided) to each end of the Main Module, using two screws for each bracket.
3. Choose a location in the rack for the Main Module.



Note: The Main Module occupies one U-space. A notched hole (or a number, on newer racks) on the rack's vertical rail denotes the middle of a U-space.

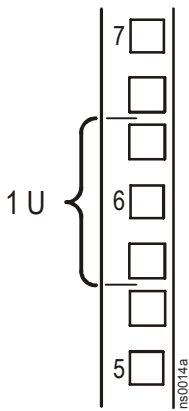

4. Insert cage nuts (provided with the rack) on the vertical mounting rails above a number at the top of a U-space in your rack and below the same number at the bottom of the U-space.
5. Align the mounting holes of the brackets with the installed cage nuts, and insert four mounting screws (provided with the rack) to secure the brackets to the rack.

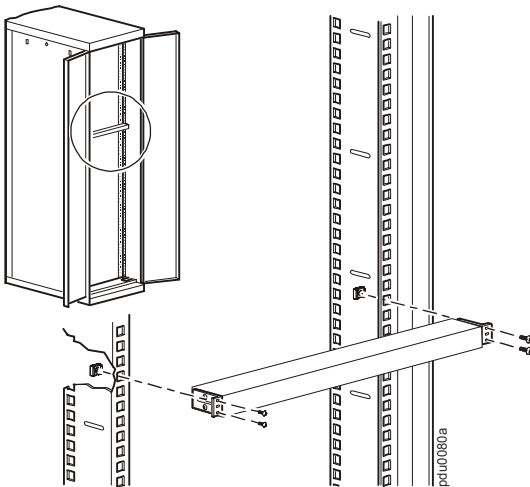

Installation—TH Module

Add TH Modules to the Main Module to monitor additional racks. The Main Module can support a maximum of 32 TH Modules (with additional power supplies).



Connecting TH Modules

To connect the TH Module to the Main Module:

1. Connect the first TH Module to either port marked A-Link on the rear of the Main Module, using a standard CAT5 (or equivalent) Ethernet patch cable. Do not use a crossover cable for connection.



Note: A-Link is an APC proprietary CAN (Controller Area Network) bus. Devices compatible with A-Link are not Ethernet devices and cannot coexist on an Ethernet bus with other networking devices, such as hubs and switches.

2. Connect the cable from the Main Module to the top A-Link connector labeled  (indicating “input”) on the TH Module. Connect the bottom A-Link connector labeled  (indicating “output”) to the next TH Module.
3. Plug an APC terminator into the unused A-Link port at each end of the string.

The Main Module does not have to be at the beginning of the chain of cascaded modules. You can cascade TH Modules from both A-Link ports of the Main Module. Always connect the Main Module to the **input** connector on the TH Module, as described in step 2.



Note: The maximum combined length of all A-Link cables is 1000 m (3,280 ft).



Note: You cannot cascade Main Modules. Install only one Main Module per system.

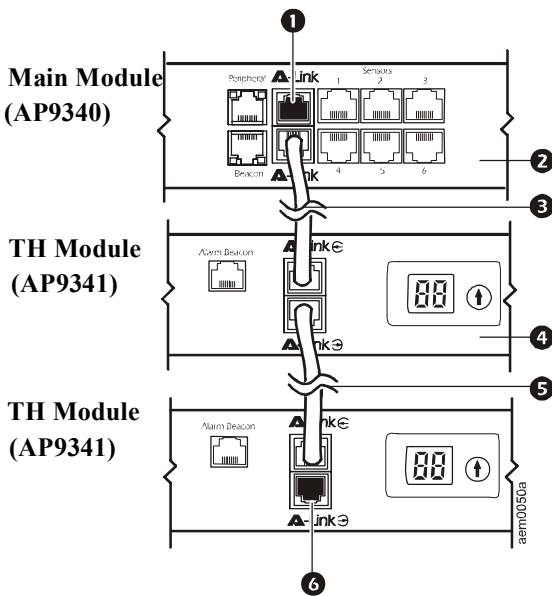

- 1 A-Link port used to plug in an APC terminator.
- 2 Main Module monitoring connected devices.
- 3 CAT5 (or equivalent) cable connecting to the TH Module.
- 4 TH Module to be monitored by the Main Module.

- 5 CAT5 (or equivalent) cable connecting to the next TH Module in the cascading configuration.

- 6 This port may be used to link to a TH Module or to plug in an APC terminator.

Adding power supplies



Warning: The first time a TH Module receives power, it requests a unique identification address from the Main Module. It uses this address to communicate with the Main Module. If the TH Module is not part of the system when it receives power for the first time, it cannot ensure that its identification address is unique, and communication problems may arise.

To avoid communication problems, connect the TH Module to the Main Module or to a TH Module that is part of the system before connecting a stabilized power supply to the 24 Vdc Input.

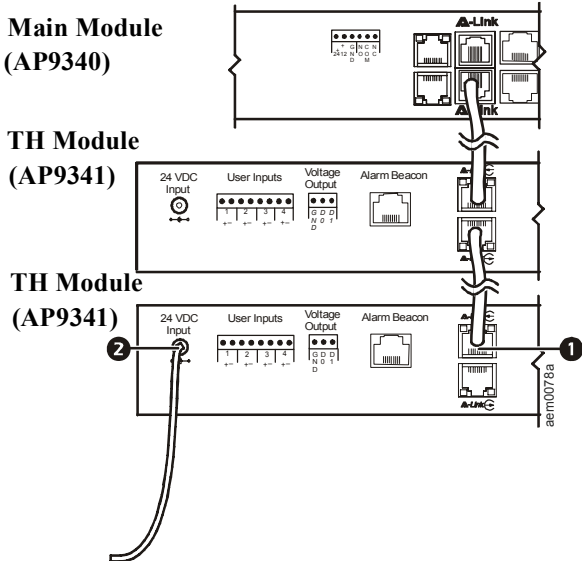

- 1 Connect the TH Module to the system.
- 2 Add a stabilized power supply (AP9505i) where needed.

If the system includes beacons, or devices attached to the +12 Vdc or +24 Vdc Voltage Output connector, attach a stabilized power supply (AP9505i) to the 24 Vdc Input of every third TH Module.

If the system does not include any beacons or voltage output connections, connect a stabilized power supply (AP9505i) to the 24 Vdc Input of every tenth TH Module.

How to wire Modbus

The Modbus interface supports 2-wire RS-485, plus ground. Modbus can be configured to communicate at either 9600 or 19200 bps. The default setting is 9600 bps.

Modbus requires both termination and polarization resistors at the bus master. Each end of the bus requires a 150-ohm resistor, and the bus also requires a 400–650-ohm resistor from D1 to +5 Vdc and from D0 to GND.

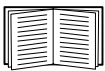
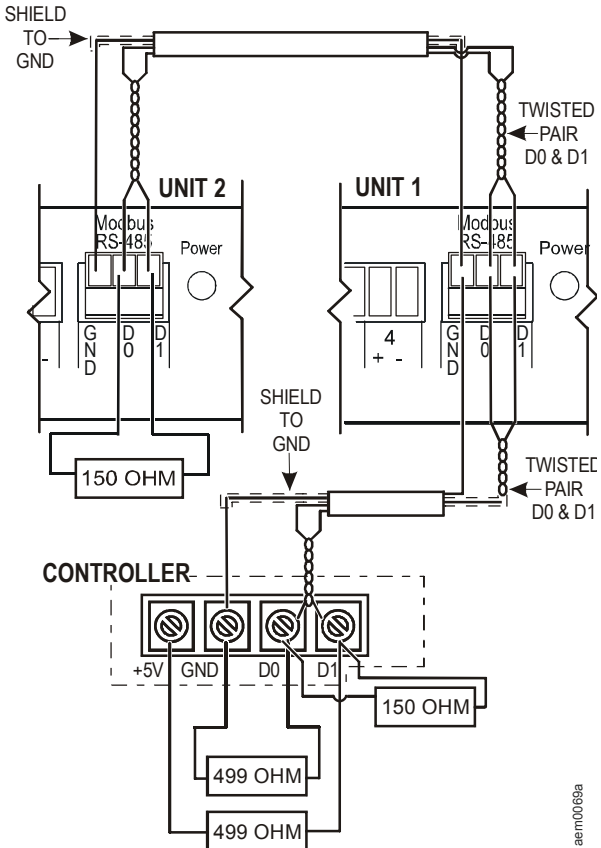

For more information, see the Modbus standard at www.modbus.org. Search for the *Modbus Serial Line Implementation Guide*.

Installation—Accessories

Sensors

Selecting a location for the sensor:

Install the sensor in a location that represents the air to be monitored. Avoid placing the sensor anywhere that may affect the sensor reading, such as near windows, room entrances, air ducts, other heat sources, or in direct sunlight.

To install a sensor on the vertical rail of an APC rack:

1. Determine a location on the vertical rail that will allow you to route and secure the 4-m (13-ft) cord neatly.

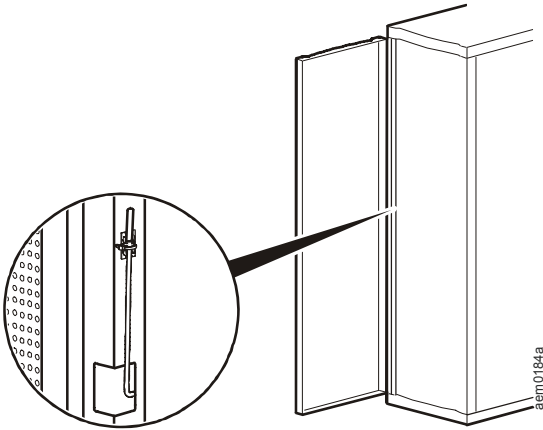

2. Peel the backing off the adhesive side of a sensor mount, and press the cable mount firmly to the vertical rail.
3. Thread a tie wrap through the sensor mount.
4. Secure the sensor to the sensor mount with the tie. Tighten and trim the tie wrap.
5. Thread the sensor cord through the opening in the front post of the rack.
6. Route the cords between the vertical support rail and the side panel. Each sensor cord may be extended to a maximum of 15 m (50 ft), using RJ-45 couplings and standard CAT5 cables.

To install a sensor on the door of an APC rack:

1. For optimal sensor performance, install the sensor near the top of the rack door. The bottom of the rack door will not accurately represent the temperature of the air in the room.
2. Thread a tie wrap through the door holes, skipping one hole in the middle.

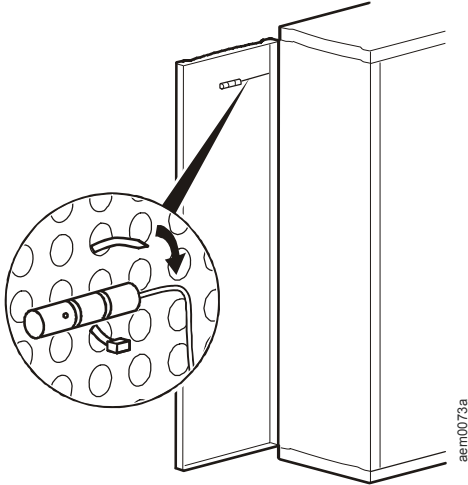

–If you have a temperature/humidity sensor, place the sensor in the middle of the tie wrap, and pull the tie wrap around a ridge on the sensor casing.

–If you have a temperature sensor, pull the tie wrap around the sensor cord, about 1/2-in (1 1/4-cm) from the sensor.

3. Tighten and trim the tie wrap.
4. To route the sensor cord, choose a location on the inside of the door frame that is even with the sensor.

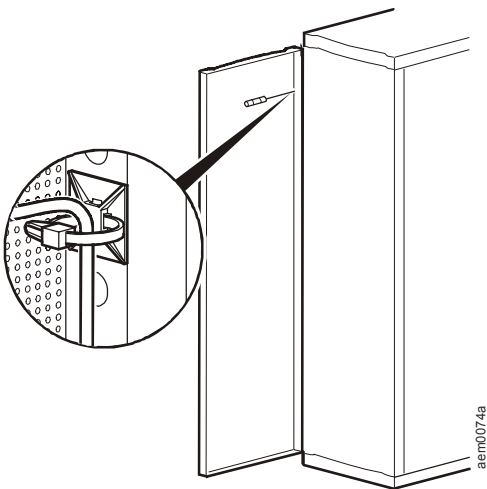

5. Peel the backing off the adhesive side of a cable mount, and press the cable mount firmly to the inside of the door frame. Thread a tie wrap through the cable mount, and secure the sensor cord with the tie wrap. Tighten and trim the tie wrap.

- To secure the sensor cord, choose a location near the middle of the door frame, and repeat step 5.



Note: If you use more than one sensor per rack, route the sensor cord farthest from the middle of the rack first. When routing the sensor cord closest to the middle of the rack, secure all sensor cords in the tie wrap.

- With the door fully open, thread the sensor cords through the opening in the front post of the rack.

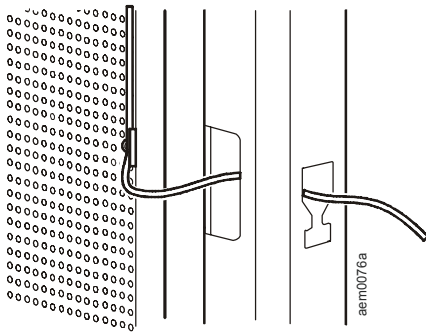

- Route the cords between the vertical support rail and the side panel. Each 4-m (13-ft) sensor cord may be extended to a maximum of 15 m (50 ft), using RJ-45 couplings and standard CAT5 cables.

To install sensors in another location:

- Use one of the following methods, depending on the type of surface on which you are mounting the sensor:
 - To mount the sensor on a wall or other smooth surface, peel the backing off the adhesive of the sensor mount, and place the sensor mount onto the wall.
 - To mount the sensor on a rough wall or porous surface, first install the wall anchor. Then attach the adhesive sensor mount to the wall anchor using the provided flat-head screw.
- Thread a tie wrap through the sensor mount, and secure the sensor with the tie. Tighten the tie wrap and trim any excess.
- Neatly route the sensor cord and connect the sensor to the APC device.

Alarm beacon (optional)

1. Install the alarm beacon in a visible position either on the roof of the rack or inside the rack.
2. If you install the beacon on the roof, route its cable through the provided holes, as shown in the following illustration.

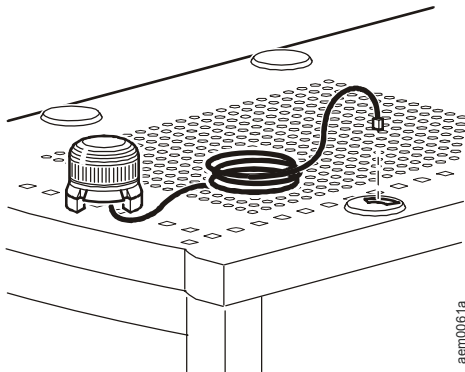

3. Plug the cable into the **Alarm Beacon** port.
4. You can extend the cable to a maximum of 100 m (330 ft), using RJ-45 couplings and standard CAT5 cables.

User inputs (optional)

There are four user input connection points provided on the Main Module. These inputs use screw terminal connections. Each may optionally be configured as:

- 5 V dry contact input (Normally Open [N.O.] or Normally Closed [N.C.])
- 0–5 Vdc digital input
- 0–5 Vdc analog input
- 4–20 mA current loop input

The graphics below and on the next page show example connections for N.O. and N.C. dry contacts, 2-wire 4–20 mA current loop input, and 4-wire 4–20 mA current loop input.

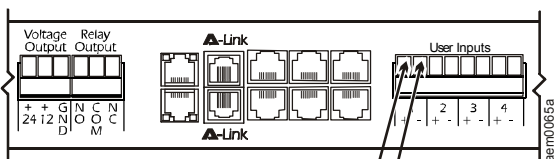

**Normally Open (N.O.) Contact
Closed for Alarm**

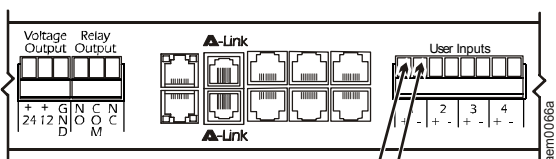

**Normally Closed (N.C.) Contact
Open for Alarm**

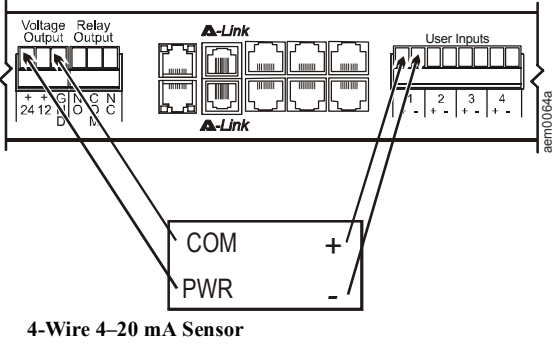
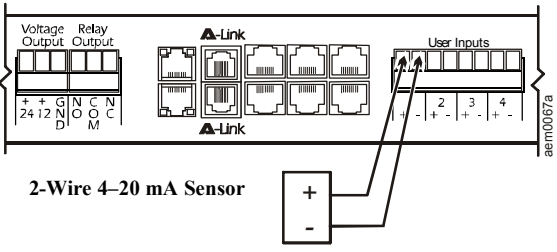

Quick Configuration



Note: Disregard the procedures in this section if you have APC InfraStruXure Central or InfraStruXure Manager as part of your system. See the documentation for your InfraStruXure device for more information.

Overview

You must configure the following TCP/IP settings before the Main Module can operate on a network:

- IP address of the Main Module
- Subnet mask
- Default gateway



Note: If a default gateway is unavailable, use the IP address of a computer that is located on the same subnet as the Main Module and that is usually running. The Main Module uses the default gateway to test the network when traffic is very light.



Caution: Do not use the loopback address (127.0.0.1) as the default gateway address for the Main Module. It disables the card and requires you to reset TCP/IP settings to their defaults using a local serial login.



See “Watchdog Features” in the “Introduction” of the Environmental Manager: Main Module *User’s Guide* for more information about the watchdog role of the default gateway.

TCP/IP Configuration Methods

Use one of the following methods to define the TCP/IP settings needed by the Main Module:

- APC Device IP Configuration Wizard (see “APC Device IP Configuration Wizard” on page 16).
- BOOTP or DHCP server (see “BOOTP & DHCP configuration” on page 16).
- Local computer (see “Local access to the control console” on page 18).
- Networked computer (see “Remote access to the control console” on page 18).

APC Device IP Configuration Wizard

You can use the APC Device IP Configuration Wizard at a computer running Windows[®] 2000, Windows Server 2003, or Windows XP to configure the basic TCP/IP settings of the Main Module.



Note: Most software firewalls must be temporarily disabled for the Wizard to discover unconfigured Main Modules.

1. Insert the *Utility* CD into a computer on your network.
2. If autorun is enabled, the user interface of the CD starts when you insert the CD. Otherwise, open the file **contents.htm** on the CD.
3. Click **Device IP Configuration Wizard** and follow the instructions.



Note: If you leave the **Start a Web browser when finished** option enabled, you can use **apc** for both the **User Name** and **Password** to access the Main Module through your browser.

.ini file utility

To configure multiple Main Modules, or to configure a Main Module from a user configuration file, see the *Environmental Manager: Main Module User's Guide*, available on the enclosed *Utility* CD.

BOOTP & DHCP configuration

At the Web interface, select the **Administration** tab, **Network** from the top menu bar, then **TCP/IP** from the left navigation menu, to identify how TCP/IP settings will be defined. The default TCP/IP configuration setting, **BOOTP & DHCP**, assumes that a properly configured BOOTP or DHCP server is available to provide TCP/IP settings to the Main Module. The Main Module first attempts to discover a properly configured BOOTP server, and then a DHCP server. It repeats this pattern until it discovers a BOOTP or DHCP server.

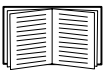

If neither of these servers is available, see “APC Device IP Configuration Wizard” on this page, “Local access to the control console” on page 18, or “Remote access to the control console” on page 18 to configure the needed TCP/IP settings.



A user configuration (.ini) file can function as a BOOTP or DHCP boot file. For more information, see the TCP/IP configuration section of the *Environmental Manager: Main Module User's Guide*, available on the enclosed *Utility* CD, or on the APC Web site, www.apc.com.

BOOTP. For the Main Module to use a BOOTP server to configure its TCP/IP settings, it must find a properly configured RFC951-compliant BOOTP server.

1. In the BOOTPTAB file of the BOOTP server, enter the Main Module's MAC address, IP address, subnet mask, and default gateway, and, optionally, a bootup file name. For the MAC address, look on the bottom of the Main Module or on the Quality Assurance slip included in the package.
2. When the Main Module starts, the BOOTP server provides it with the TCP/IP settings.
 - If you specified a bootup file name, the Main Module attempts to transfer that file from the BOOTP server using TFTP or FTP. The Main Module assumes all settings specified in the bootup file.
 - If you did not specify a bootup file name, you can configure the Main Module remotely by using the Web interface or control console; the user name and password are both **apc**, by default.

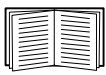

To create the bootup file, see your BOOTP server documentation.

DHCP. You can use an RFC2131/RFC2132-compliant DHCP server to configure the TCP/IP settings for the Main Module.

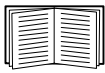

This section briefly summarizes the Main Module's communication with a DHCP server. For more detail about how a DHCP server is used to configure the network settings for the Main Module, see "DHCP Configuration" in the *Environmental Manager: Main Module User's Guide*.

1. The Main Module sends out a DHCP request that uses the following to identify itself:
 - Vendor Class Identifier (APC by default)
 - Client Identifier (by default, the Main Module's MAC address value)
 - User Class Identifier (by default, the identification of the Main Module's application firmware)
2. A properly configured DHCP server responds with a DHCP offer that includes all of the settings that the Main Module needs for network communication. The DHCP offer also includes the Vendor Specific Information option (DHCP option 43). By default, the Main Module ignores DHCP offers that do not encapsulate the APC cookie in DHCP option 43 using the following hexadecimal format:

Option 43 = 01 04 31 41 50 43

where

- the first byte (01) is the code
- the second byte (04) is the length
- the remaining bytes (31 41 50 43) are the APC cookie

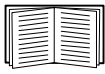

See your DHCP server documentation to add code to the Vendor Specific Information option.

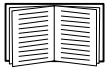

To disable the requirement that a DHCP offer include the APC cookie, use the **DHCP Cookie Is** setting in the control console:
Network>TCP/IP>Boot Mode>DHCP only>Advanced>DHCP Cookie Is.

Local access to the control console

You can use a local computer that connects to the Main Module through the serial port on the rear of the unit to access the control console.

1. Select a serial port at the local computer, and disable any service that uses that port.
2. Use the provided RS-232 configuration cable to connect the selected port to the serial port on the rear panel of the Main Module.
3. Run a terminal program (such as HyperTerminal[®]) on your computer and configure the selected port for 9600 bps, 8 data bits, no parity, 1 stop bit, and no flow control, and save the changes.
4. Press ENTER to display the **User Name** prompt.
5. Use **apc** for the user name and password.
6. See “Control console” on page 19 to finish the configuration.

Remote access to the control console

From any computer on the same network as the Main Module, you can use ARP and Ping to assign an IP address to a Main Module, and then use Telnet to access that Main Module’s control console and configure the needed TCP/IP settings.



Note: After the Main Module has its IP address configured, you can use Telnet, without first using ARP and Ping, to access that Main Module.

1. Use the MAC address of the Main Module in the ARP command to define the IP address.

For example, to define an IP address of 156.205.14.141 for a Main Module that has a

MAC address of 00 c0 b7 63 9f 67, use one of the following commands:

–Windows[®] command format:

```
arp -s 156.205.14.141 00-c0-b7-63-9f-67
```

–LINUX command format:

```
arp -s 156.205.14.141 00:c0:b7:63:9f:67
```

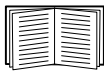

For the MAC address, look on the bottom of the Main Module or on the Quality Assurance slip included in the package.

2. Use Ping with a size of 113 bytes to assign the IP address defined by the ARP command. For example:

–Windows command format:

```
ping 156.205.14.141 -l 113
```

–LINUX command format:

```
ping 156.205.14.141 -s 113
```

3. Use Telnet to access the Main Module at its newly assigned IP address. For example:

```
telnet 156.205.14.141
```

4. Use **apc** for both **User Name** and **Password**.
5. See “Control console” on this page to finish the configuration.

Control console

After you log on at the control console, as described in “Local access to the control console” on page 18 or “Remote access to the control console” on page 18:

1. Choose **Network** from the **Control Console** menu.
2. Choose **TCP/IP** from the **Network** menu.
3. If you are not using a **BOOTP** or **DHCP** server to configure the **TCP/IP** settings, select the **Boot Mode** menu. Select **Manual boot mode**, and then press ENTER to return to the **TCP/IP** menu. (Changes will take effect when you log out.)
4. Set the **System IP**, **Subnet Mask**, and **Default Gateway** address values.
5. Press CTRL+C to exit to the **Control Console** menu.
6. Log out (option 4 in the **Control Console** menu).



Note: If you disconnected a cable during the procedure described in “Local access to the control console” on page 18, reconnect that cable and restart the associated service.

Accessing a Configured Main Module

Overview

After the Main Module is running on your network, you can access the configured Main Module through the following interfaces:

- Web interface (HTTP or HTTPS protocol)
- Telnet or Secure SHell (SSH)
- SNMP
- FTP or Secure CoPy (SCP) to upgrade firmware
- Modbus



For more information on the interfaces, see the *Environmental Manager: Main Module User's Guide*.

Web interface

Use Microsoft® Internet Explorer® 5.5 and higher (on Windows® operating systems only), Mozilla-based browsers that support Firefox 1.x (on all operating systems), or Netscape® 7.x and higher (on all operating systems) to access the Web interface of the Main Module. Other commonly available browsers also may work but have not been fully tested by APC.

When you use the Web browser to configure Main Module options or to view the event and data logs, you can use either of the following protocols:

- The HTTP protocol (enabled by default), which provides authentication by user name and password but no encryption.
- The HTTPS protocol, which provides extra security through Secure Sockets Layer (SSL); encrypts user names, passwords, and data being transmitted; and authenticates the Main Module by means of digital certificates.

To access the Web interface and configure the security of your device on the network:

1. Address the Main Module by its IP address or DNS name (if configured).
2. Enter the user name and password (by default, **apc** and **apc** for an Administrator).
3. To enable or disable the HTTP or HTTPS protocols, use the **Network** menu on the **Administration** tab, and select the **access** option under the **Web** heading on the left navigation menu.



For more information on selecting and configuring network security, see the *Security Handbook*, available on the *Utility CD* or from the APC Web site, www.apc.com.

Telnet and SSH

You can access the control console through Telnet or Secure SHell (SSH), depending on which is enabled. Select the **Administration** tab, the **Network** option on the top menu bar, and then the **access** option under **Console** on the left navigation menu. By default, Telnet is enabled. Enabling SSH automatically disables Telnet.

Telnet for basic access. Telnet provides the basic security of authentication by user name and password, but not the high-security benefits of encryption. To use Telnet to access a Main Module's control console:

1. At a command prompt, use the following command line, and press ENTER:

```
telnet address
```

As *address*, use the Main Module's IP address or DNS name (if configured).

2. Enter the user name and password (by default, **apc** and **apc** for an Administrator, or **device** and **apc** for a Device User).

SSH for high-security access. If you use the high security of SSL for the Web interface, use Secure SHell (SSH) for access to the control console. SSH encrypts user names, passwords, and transmitted data.

The interface, user accounts, and user access rights are the same whether you access the control console through SSH or Telnet, but to use SSH, you must first configure SSH and have an SSH client program installed on your computer.



See the Environmental Manager: Main Module *User's Guide* for more information on configuring and using SSH.

Simple Network Management Protocol (SNMP)

SNMPv1 only. After you add the PowerNet[®] MIB to a standard SNMP MIB browser, you can use that browser to access the Main Module. All user names, passwords, and community names for SNMP are transferred over the network as plain text. The default read community name is **public**; the default read/write community name is **private**.

SNMPv3 only. For SNMP GETs, SETs, and trap receivers, SNMPv3 uses a system of user profiles to identify users. An SNMPv3 user must have a user profile assigned in the MIB software program to perform GETs and SETs, browse the MIB, and receive traps. The default settings are **no authentication** and **no privacy**.



Note: To use SNMPv3, you must have a MIB program that supports SNMPv3.

The Main Module supports only MD5 authentication and DES encryption.

SNMPv1 and SNMPv3. To use InfraStruXure Central or InfraStruXure Manager to manage the Main Module on the public network of an InfraStruXure system, you must have SNMPv1 enabled in the unit interface. Read access allows InfraStruXure devices to receive traps from the Main Module. Write access is required while you set the InfraStruXure device as a trap receiver.

To enable or disable SNMP access, you must be an Administrator. Select the **Administration** tab, select the **Network** menu on the top menu bar, and use the **access** option under **SNMPv1** or **SNMPv3** on the left navigation menu.

FTP and SCP

You can use FTP (enabled by default) or Secure CoPy (SCP) to transfer downloaded firmware to the Main Module, or to access a copy of the event or data logs of the Main Module. SCP provides the higher security of encrypted data transmission and is enabled automatically when you enable SSH.

To use InfraStruXure Manager to manage the Main Module, you must have **FTP Server** enabled in the Main Module interface. To enable or disable **FTP Server** access, you must be an Administrator. On the **Administration** tab, select the **Network** menu on the top menu bar, and use the **FTP server** option on the left navigation menu.

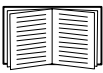

In the Environmental Manager: Main Module *User's Guide*, see the following sections:

- To transfer firmware, see “File Transfers.”
- To retrieve a copy of the event or data log, see “Use FTP or SCP to retrieve log files.”

Modbus

Modbus lets you view the Main Module through the interface of your building management system. It is read-only.

The Modbus interface supports 2-wire RS-485, plus ground.



Note: Modbus can be configured to run at either 9600 or 19200 bps.

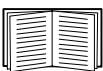

To access the Modbus register map, go to the APC Web site, www.apc.com, and search for part number **AP9340**.

Recovering from a Lost Password

You can use a local computer (a computer that connects to the Main Module through the serial port) to access the control console.

1. Select a serial port at the local computer, and disable any service that uses that port.
2. Connect the provided RS-232 configuration cable to the selected port on the computer and to the RS-232 console port at the Main Module.
3. Run a terminal program (such as HyperTerminal) on your computer and configure the selected port for 9600 bps, 8 data bits, no parity, 1 stop bit, and no flow control.
4. Press ENTER, repeatedly if necessary, to display the **User Name** prompt. If you are unable to display the **User Name** prompt, verify the following:
 - The serial port is not in use by another application.
 - The terminal settings are correct as specified in step 3.
 - The correct cable is being used as specified in step 2.
5. Press the **Reset** switch. The Status LED will flash alternately orange and green. Press the **Reset** button a second time immediately while the LED is flashing to reset the user name and password to their defaults temporarily.
6. Press ENTER as many times as necessary to redisplay the **User Name** prompt, then use the default, **apc**, for the user name and password. (If you take longer than 30 seconds to log on after the **User Name** prompt is redisplayed, you must repeat step 5 and log on again.)
7. From the **Control Console** menu, select **System**, then **User Manager**.
8. Select **Administrator**, and change the **User Name** and **Password** settings, both of which are now defined as **apc**.
9. Press CTRL+C, log off, reconnect any serial cable you disconnected, and restart any service you disabled.

Specifications

Environmental Manager Main Module

Electrical

Input voltage, nominal	100–240 Vac; 50/60 Hz
Maximum total current draw	10 A
Maximum output voltage	Defined by input voltage
Maximum output current	10 A

Physical

Dimensions (H x W x D)	4.42 x 43.20 x 4.42 cm (1.74 x 17.00 x 1.74 in)
Weight	1.10 kg (2.50 lb)
Shipping weight	2.70 kg (6.00 lb)
Shipping dimensions (H x W x D)	6.70 x 45.00 x 22.50 cm (2.62 in x 17.75 x 8.87 in)

Environmental

Elevation (above MSL)	
Operating	0 to 3000 m (0 to 10,000 ft)
Storage	0 to 15 000 m (0 to 50,000 ft)
Temperature	
Operating	0 to 45°C (32 to 113°F)
Storage	-15 to 65°C (5 to 149°F)
Humidity	
Operating	0 to 95%, non-condensing
Storage	0 to 95%, non-condensing

Compliance

Approvals	CE, cUL tested to CSA C22.2 No. 60950-1, UL 60950-1, FCC Part 15 Class A, ICES-003 Class A, VCCI Class A, EN 55022 Class A, EN 55024, EN 61000-3-2, EN 61000-3-3, AS/NZS 3548, VDE tested to EN60950-1
-----------	--

Sensors

Temperature/Humidity (AP9335TH)

Temperature accuracy	$\pm 2^{\circ}\text{C}$ ($\pm 3^{\circ}\text{F}$), from 0 to 40°C (32 to 104°F)
Humidity accuracy	$\pm 4\%$ RH, 20 to 90% RH, at 25°C (77°F) $\pm 8\%$ RH, 30 to 80% RH, from 15 to 30°C (59 to 95°F)
Sensor operating temperature	-10 to 70°C (14 to 159°F)
User input response time	200 mS
Maximum length of cable	15.2 m (50 ft)

Temperature (AP9335T)

Temperature accuracy	$\pm 2^{\circ}\text{C}$ ($\pm 3^{\circ}\text{F}$), from 0 to 40°C (32 to 104°F)
Sensor operating temperature	-10 to 70°C (14 to 159°F)
Maximum length of cable	15.2 m (50 ft)

A-Link

Maximum length of cable	1000 m (3,280 ft)
-------------------------	-------------------

Beacon

Maximum length of cable	100 m (330 ft)
-------------------------	----------------

Door contacts

Maximum length of cable	100 m (330 ft)
-------------------------	----------------

Output Voltages

Voltages	12 Vdc, 24 Vdc
Current	75 mA total for 12 V and 24 V load

Relay Output

Current capacity of relay outputs	1 A, 30 V AC/DC
-----------------------------------	-----------------

Product Information

Two-Year Factory Warranty

This warranty applies only to the products you purchase for your use in accordance with this manual.

Terms of warranty

APC warrants its products to be free from defects in materials and workmanship for a period of two years from the date of purchase. APC will repair or replace defective products covered by this warranty. This warranty does not apply to equipment that has been damaged by accident, negligence or misapplication or has been altered or modified in any way. Repair or replacement of a defective product or part thereof does not extend the original warranty period. Any parts furnished under this warranty may be new or factory-remanufactured.

Non-transferable warranty

This warranty extends only to the original purchaser who must have properly registered the product. The product may be registered at the APC Web site, www.apc.com.

Exclusions

APC shall not be liable under the warranty if its testing and examination disclose that the alleged defect in the product does not exist or was caused by end user's or any third person's misuse, negligence, improper installation or testing. Further, APC shall not be liable under the warranty for unauthorized attempts to repair or modify wrong or inadequate electrical voltage or connection, inappropriate on-site operation conditions, corrosive atmosphere, repair, installation, exposure to the elements, Acts of God, fire, theft, or installation contrary to APC recommendations or specifications or in any event if the APC serial number has been altered, defaced, or removed, or any other cause beyond the range of the intended use.

THERE ARE NO WARRANTIES, EXPRESS OR IMPLIED, BY OPERATION OF LAW OR OTHERWISE, OF PRODUCTS SOLD, SERVICED OR FURNISHED UNDER THIS AGREEMENT OR IN CONNECTION HERewith. APC DISCLAIMS ALL IMPLIED WARRANTIES OF MERCHANTABILITY, SATISFACTION AND FITNESS FOR A PARTICULAR PURPOSE. APC EXPRESS WARRANTIES WILL NOT BE ENLARGED, DIMINISHED, OR AFFECTED BY AND NO OBLIGATION OR LIABILITY WILL ARISE OUT OF, APC RENDERING OF TECHNICAL OR OTHER ADVICE OR SERVICE IN

CONNECTION WITH THE PRODUCTS. THE FOREGOING WARRANTIES AND REMEDIES ARE EXCLUSIVE AND IN LIEU OF ALL OTHER WARRANTIES AND REMEDIES. THE WARRANTIES SET FORTH ABOVE CONSTITUTE APC'S SOLE LIABILITY AND PURCHASER'S EXCLUSIVE REMEDY FOR ANY BREACH OF SUCH WARRANTIES. APC WARRANTIES EXTEND ONLY TO PURCHASER AND ARE NOT EXTENDED TO ANY THIRD PARTIES.

IN NO EVENT SHALL APC, ITS OFFICERS, DIRECTORS, AFFILIATES OR EMPLOYEES BE LIABLE FOR ANY FORM OF INDIRECT, SPECIAL, CONSEQUENTIAL OR PUNITIVE DAMAGES, ARISING OUT OF THE USE, SERVICE OR INSTALLATION, OF THE PRODUCTS, WHETHER SUCH DAMAGES ARISE IN CONTRACT OR TORT, IRRESPECTIVE OF FAULT, NEGLIGENCE OR STRICT LIABILITY OR WHETHER APC HAS BEEN ADVISED IN ADVANCE OF THE POSSIBILITY OF SUCH DAMAGES. SPECIFICALLY, APC IS NOT LIABLE FOR ANY COSTS, SUCH AS LOST PROFITS OR REVENUE, LOSS OF EQUIPMENT, LOSS OF USE OF EQUIPMENT, LOSS OF SOFTWARE, LOSS OF DATA, COSTS OF SUBSTITUENTS, CLAIMS BY THIRD PARTIES, OR OTHERWISE.

NO SALESMAN, EMPLOYEE OR AGENT OF APC IS AUTHORIZED TO ADD TO OR VARY THE TERMS OF THIS WARRANTY. WARRANTY TERMS MAY BE MODIFIED, IF AT ALL, ONLY IN WRITING SIGNED BY AN APC OFFICER AND LEGAL DEPARTMENT.

Warranty claims

Customers with warranty claims issues may access the APC customer support network through the Support page of the APC Web site, www.apc.com/support. Select your country from the country selection pull-down menu at the top of the Web page. Select the Support tab to obtain contact information for customer support in your region.

Life-Support Policy

General policy

American Power Conversion (APC) does not recommend the use of any of its products in the following situations:

- In life-support applications where failure or malfunction of the APC product can be reasonably expected to cause failure of the life-

support device or to affect significantly its safety or effectiveness.

- In direct patient care.

APC will not knowingly sell its products for use in such applications unless it receives in writing assurances satisfactory to APC that (a) the risks of injury or damage have been minimized, (b) the customer assumes all such risks, and (c) the liability of APC is adequately protected under the circumstances.

Examples of life-support devices

The term *life-support device* includes but is not limited to neonatal oxygen analyzers, nerve stimulators (whether used for anesthesia, pain relief, or other purposes), autotransfusion devices, blood pumps, defibrillators, arrhythmia detectors and alarms, pacemakers, hemodialysis systems, peritoneal dialysis systems, neonatal ventilator incubators, ventilators (for adults and infants), anesthesia ventilators, infusion pumps, and any other devices designated as “critical” by the U.S. FDA.

Hospital-grade wiring devices and leakage current protection may be ordered as options on many APC UPS systems. APC does not claim that units with these modifications are certified or listed as hospital-grade by APC or any other organization. Therefore these units do not meet the requirements for use in direct patient care.

Radio Frequency Interference



Changes or modifications to this unit not expressly approved by the party responsible for compliance could void the user's authority to operate this equipment.

USA—FCC

This equipment has been tested and found to comply with the limits for a Class A digital device, pursuant to part 15 of the FCC Rules. These limits are designed to provide reasonable protection against harmful interference when the equipment is operated in a commercial environment. This equipment generates, uses, and can radiate radio frequency energy and, if not installed and used in accordance with this user manual, may cause harmful interference to radio communications. Operation of this equipment in a residential area is likely to cause harmful interference. The user will bear sole responsibility for correcting such interference.

Canada—ICES

This Class A digital apparatus complies with Canadian ICES-003.

Cet appareil numérique de la classe A est conforme à la norme NMB-003 du Canada.

Japan—VCCI

This is a Class A product based on the standard of the Voluntary Control Council for Interference by Information Technology Equipment (VCCI). If this equipment is used in a domestic environment, radio disturbance may occur, in which case, the user may be required to take corrective actions.

この装置は、情報処理装置等電波障害自主規制協議会（VCCI）の基準に基づくクラス A 情報技術装置です。この装置を家庭環境で使用すると、電波妨害を引き起こすことがあります。この場合には、使用者が適切な対策を講ずるよう要求されることがあります。

Taiwan—BSMI

警告使用者：
這是甲類的資訊產品，在居住的環境中使用時，可能會造成射頻干擾，在這種情況下，使用者會被要求採取某些適當的對策。

Australia and New Zealand

Attention: This is a Class A product. In a domestic environment this product may cause radio interference in which case the user may be required to take adequate measures.

European Union

This product is in conformity with the protection requirements of EU Council Directive 89/336/EEC on the approximation of the laws of the Member States relating to electromagnetic compatibility. APC cannot accept responsibility for any failure to satisfy the protection requirements resulting from an unapproved modification of the product.

This product has been tested and found to comply with the limits for Class A Information Technology Equipment according to CISPR 22/European Standard EN 55022. The limits for Class A equipment were derived for commercial and industrial environments to provide a reasonable protection against interference with licensed communication equipment.

Attention: This is a Class A product. In a domestic environment this product may cause radio interference in which case the user may be required to take adequate measures.

APC Worldwide Customer Support

Customer support for this or any other APC product is available at no charge in any of the following ways:

- Visit the APC Web site to access documents in the APC Knowledge Base and to submit customer support requests.
 - **www.apc.com** (Corporate Headquarters)
Connect to localized APC Web sites for specific countries, each of which provides customer support information.
 - **www.apc.com/support/**
Global support searching APC Knowledge Base and using e-support.
- Contact an APC Customer Support center by telephone or e-mail.
 - Regional centers

Direct InfraStruXure Customer Support Line	(1)(877)537-0607 (toll free)
APC headquarters U.S., Canada	(1)(800)800-4272 (toll free)
Latin America	(1)(401)789-5735 (USA)
Europe, Middle East, Africa	(353)(91)702000 (Ireland)
Western Europe (inc. Scandinavia)	+800 0272 0272
Japan	(0) 3 6402-2001
Australia, New Zealand, South Pacific area	(61) (2) 9955 9366 (Australia)

- Local, country-specific centers: go to **www.apc.com/support/contact** for contact information.

Contact the APC representative or other distributor from whom you purchased your APC product for information on how to obtain local customer support.

Entire contents copyright 2007 American Power Conversion Corporation. All rights reserved. Reproduction in whole or in part without permission is prohibited. APC, the APC logo, InfraStruXure, NetShelter, and PowerNet are trademarks of American Power Conversion Corporation. All other trademarks, product names, and corporate names are the property of their respective owners and are used for informational purposes only.

990-2379D-001

11/2007

