

Operation, Maintenance, and Troubleshooting

NetworkAIR[®] FM DX Precision Air Conditioner

60 Hz



American Power Conversion Legal Disclaimer

The information presented in this manual is not warranted by the American Power Conversion Corporation to be authoritative, error free, or complete. This publication is not meant to be a substitute for a detailed operational and site specific development plan. Therefore, American Power Conversion Corporation assumes no liability for damages, violations of codes, improper installation, system failures, or any other problems that could arise based on the use of this Publication.

The information contained in this Publication is provided as is and has been prepared solely for the purpose of evaluating data center design and construction. This Publication has been compiled in good faith by American Power Conversion Corporation. However, no representation is made or warranty given, either express or implied, as to the completeness or accuracy of the information this Publication contains.

IN NO EVENT SHALL AMERICAN POWER CONVERSION CORPORATION BE LIABLE FOR ANY DIRECT, INDIRECT, CONSEQUENTIAL, PUNITIVE, SPECIAL, OR INCIDENTAL DAMAGES (INCLUDING, WITHOUT LIMITATION, DAMAGES FOR LOSS OF BUSINESS, CONTRACT, REVENUE, DATA, INFORMATION, OR BUSINESS INTERRUPTION) RESULTING FROM, ARISING OUT, OR IN CONNECTION WITH THE USE OF, OR INABILITY TO USE THIS PUBLICATION OR THE CONTENT, EVEN IF AMERICAN POWER CONVERSION CORPORATION HAS BEEN EXPRESSLY ADVISED OF THE POSSIBILITY OF SUCH DAMAGES. AMERICAN POWER CONVERSION CORPORATION RESERVES THE RIGHT TO MAKE CHANGES OR UPDATES WITH RESPECT TO OR IN THE CONTENT OF THE PUBLICATION OR THE FORMAT THEREOF AT ANY TIME WITHOUT NOTICE.

Copyright, intellectual, and all other proprietary rights in the content (including but not limited to software, audio, video, text, and photographs) rests with American Power Conversion Corporation or its licensors. All rights in the content not expressly granted herein are reserved. No rights of any kind are licensed or assigned or shall otherwise pass to persons accessing this information.

This Publication shall not be for resale in whole or in part.

Contents

General Information.....	1
Modules, Systems, and Groups.....	1
Module	1
System	1
Group	2
Safety.....	3
Symbols Used in this Manual.....	3
Save these instructions	3
Safety symbols that may be used in this manual	3
Cross-reference symbols used in this manual	3
Safety Hazards.....	4
Lockout/tagout	4
Electrical hazards	4
Static discharge	4
Safe refrigerant handling	4
Moving parts	4
Tools and parts	4
Operation.....	5
Display Interface	5
Using the Display Interface	6
Scrolling status screens	6
Main menu screen	7
Navigating the interface	7
Password entry	7
Start the System	8
Change settings	8
Stop the System	8
Factory default settings	8
Commissioning	9
Power On/Off Procedure.....	10

Commissioning Checklists	11
Initial Inspection Checklist	11
Electrical Inspection Checklist	12
Mechanical and Refrigeration Inspection Checklist	12
Mechanical Inspection: Air-cooled Checklist	13
User Interface Box Inspection Checklist	13
Start-up Inspection Checklist	14
Final Inspection Checklist	15
Owner Acceptance	15
System Configuration	16
System options	16
System delays	19
Building management	20
Sensor setup	20
Settings for fluid-cooled options	21
Valve types	22
Actuator types	22
Economizer isolation valve (optional)	23
Coil fluid temperature activation threshold and deadband	24
Contacts and Relays	25
Input contacts	25
Output relays	27
Module Configuration	28
Configure Module	28
Alarm detectors	28
Module Control	29
Calibrate airflow manually	29
Calibrate airflow automatically	29
Reset Variable Frequency Drive	30
Reset humidifier	30
Set up humidifier	30
Control the Environment	31
How the modes work	31
Setpoints	33
Deadbands	34
Modes	37
Essential functions	37
PID controls	38
How to tune the PIDs	38
Humidification sensitivity	39

Alarms	40
Temperature alarms	40
Humidity alarms	40
Maintenance intervals	40
Alarm delay	41
Group	42
Group configuration	42
Group settings	43
System failure events	44
Display	45
Password and time-out	45
Date and time	45
Temperature and pressure units	45
Adjust display	46
How to update the firmware	46
Reset to defaults	47
Product data	47
Network Configuration	48
View Status Readings	49
Scrolling status screens	49
Module status	49
System status	50
Group status	50
View Event Log	51
Respond to Alarms	52
Major or minor alarm LEDs	52
Control beeper	52
View active alarms	52
Clear active alarms	52
Reset System failure	52
Alarm messages and suggested actions	53

Network Management Card 61

Quick Configuration 61

Overview	61
TCP/IP configuration methods	61
APC Device IP Configuration Wizard	62
BOOTP and DHCP configuration	62
Remote access to the control console	64
Control console	65

Access a Configured Unit 66

Overview	66
Web interface	66
Telnet/SSH	66
SNMP	67
FTP/SCP	67

Recover From a Lost Password 68

Maintenance 69

Monthly Preventive Maintenance 69

Environment	69
Cleanliness	69
Mechanical	70
Electrical	70

Quarterly Preventive Maintenance 71

Mechanical	71
Electrical	71
Functional tests	72

Semi-Annual Preventive Maintenance 73

Cleanliness	73
Mechanical	73
Electrical	73
Functional tests	74

Troubleshooting 75

Warranty 81

One-Year Factory Warranty81

Terms of warranty 81

Non-transferable warranty 81

Exclusions 81

Warranty claims 82

Warranty Procedures83

Claims 83

Parts 83

General Information

Modules, Systems, and Groups

NetworkAIR **Modules** and **Expansion Modules** can be combined electronically to create **Systems** and **Groups**.

Module

A **Module** is an independent Computer Room Air Conditioner (CRAC) that operates based on its own temperature and humidity sensors.



System

A **System** is a set of one to three Modules or CRACs. System operation is based on an average of the combined temperature and humidity sensors of all the Modules in the System. The Modules in a System work together as a single unit to increase cooling capacity.

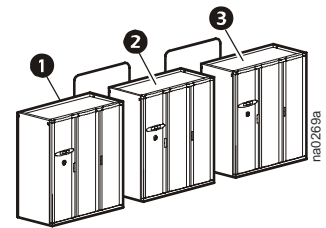

- ❶ Main Module
- ❷ Expansion Module 1
- ❸ Expansion Module 2

In a System, one of the Modules is designated as the **Main Module** and the rest of modules are designated as **Expansion Modules**. The Main Module is the controller for all the Modules in the System. It contains the Programmable Customer Input/Output Module (PCIOM) boards, the webcard, and establishes communications with the Building Management System (BMS).



Note: When using the System configuration, only the Main Module display will be operational. The Expansion Module displays will not operate.

Group

A **Group** is a set of two, three or four Systems that work together to provide redundancy and load sharing capabilities.

To enable the Modules to work in a System or Group, the only requirement is to connect them together with a CAT 5 cable terminated with RJ-45 connectors and to set the DIP switches on the controller board of each module to assign the Main Module, the Expansion Modules, and the System number.

- ❶ Main Module
- ❷ Expansion Modules

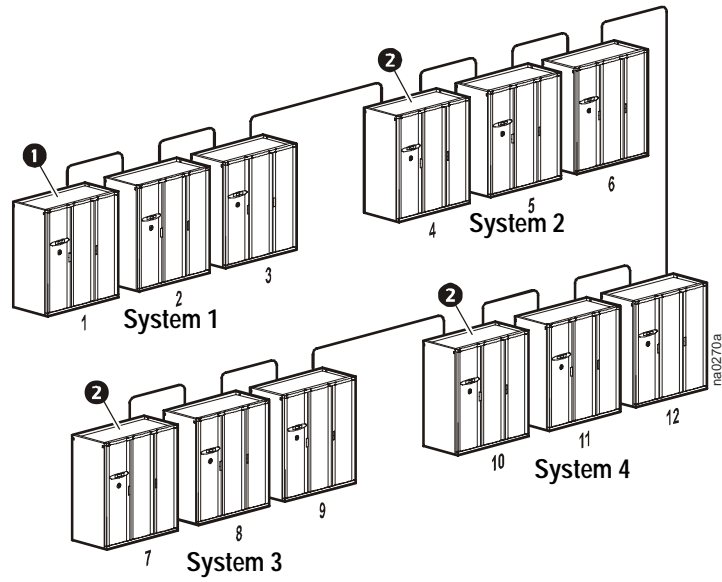

Safety

Symbols Used in this Manual

Save these instructions

This manual contains important instructions that must be followed when servicing this equipment.

Safety symbols that may be used in this manual



Electrical Hazard: Indicates an electrical hazard which, if not avoided, could result in injury or death.



Danger: Indicates a hazard which, if not avoided, could result in severe personal injury or death.



Warning: Indicates a hazard which, if not avoided, could result in personal injury or damage to product or other property.



Heavy: Indicates a heavy load that should not be lifted without assistance.



Caution: Indicates a potential hazard which, if not avoided, could result in damage to the equipment or other property.



Tip Hazard: This equipment is easily tipped. Use extreme caution when unpacking or moving.



Note: Indicates important information.

Cross-reference symbols used in this manual

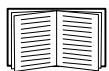

Indicates that more information is available in another location.

Safety Hazards

Lockout/tagout



Warning: Make sure to follow the lockout/tagout procedures for your site to remove access to a device and physically label the device as intentionally out of service while servicing this equipment.

Electrical hazards



Electrical Hazard: Unless otherwise indicated, remove power before attempting to service this unit. Remove power at the upstream breaker and disconnect the power cords before servicing. Failure to do so could result in serious injury or death.



Electrical Hazard: Follow all local and national electrical codes when installing or servicing a NetworkAIR FM.

Static discharge



Static Discharge: Circuit boards contained within the unit are sensitive to static electricity. Whenever possible, touch only the end-plates and use one or more of these electrostatic-discharge devices (ESDs) while handling the boards: wrist straps, heel straps, toe straps, or conductive shoes. Failure to do so may cause damage to the board and improper operation of the unit.

Safe refrigerant handling



Note: Service to components in the refrigeration loop should be performed only by a certified HVAC technician.



Note: Follow all local and national regulations when handling refrigerants.



Caution: Use applicable safety precautions when working with pressurized systems. Some piping in this unit contains refrigerant that is under pressure. Use care when working with piping or pipe fittings.

Moving parts



Warning: This equipment contains moving parts such as fans. Use care around components that are behind air blocks or separated by doors or access panels.

Tools and parts



Caution: Ensure that all spare parts and tools are removed from the equipment before operation.

Operation

Display Interface

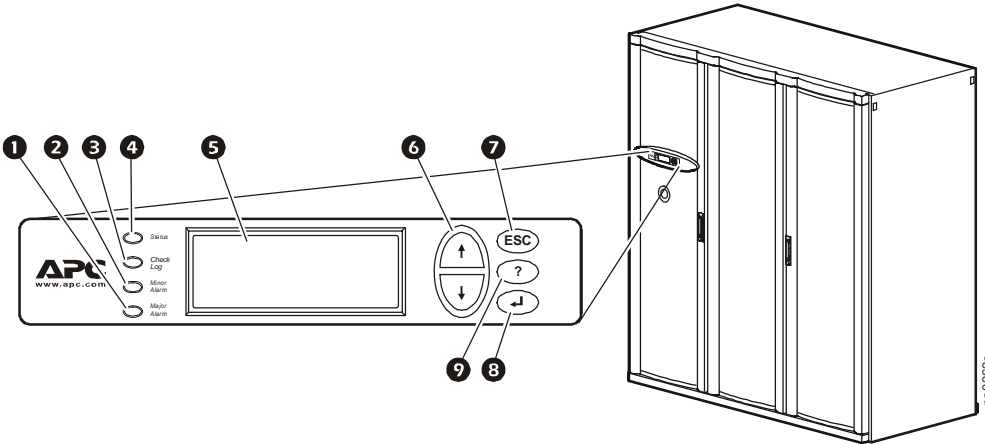

Item	Function
1 Major Alarm LED	When lit, a major alarm condition exists.
2 Minor Alarm LED	When lit, a minor alarm condition exists.
3 Check Log LED	When lit, at least one new major alarm or minor alarm or event has occurred.
4 Status LED	When lit, the Module is on.
5 Liquid Crystal Display (LCD)	View alarms, status data, instructional help, and configuration items.
6 Up and down arrow keys	Select menu items and access information.
7 ESC key	Return to previous screen.
8 ENTER key	Open menu items and input changes to Module, System, and Group settings.
9 HELP key	Display context-sensitive help. Press the HELP key for information about each option on the screen and for instructions on how to perform tasks.

Using the Display Interface

Scrolling status screens

The first time you apply power to the Module, the display initializes and runs an LED and alarm-tone test.

After start-up, the interface displays the firmware revision number (if the fast start-up is disabled). The display interface then scrolls automatically and continuously through the following nine screens of status information.

Status Screen Name	Status Information Displayed
Control Temp & Humidity	<ul style="list-style-type: none">• Temperature and humidity at the sensors being used to control the environment• Remote Temperature and Humidity (optional)• Humidity Control Method (dew point or relative humidity)
Cool/Dehum Demands	<ul style="list-style-type: none">• Cool Demand %• Dehumidify Demand %• Actual Output %
Reheat Demand	<ul style="list-style-type: none">• Reheat Demand % (Electric SCR only)
Humidify Demand	<ul style="list-style-type: none">• Humidify Demand %• Humidify Actual %
Group Status	<ul style="list-style-type: none">• Number of Systems• Setpoint Share: On/Off• Demand Fighting: On/Off
Group Status	<ul style="list-style-type: none">• System number• Role• State
Active Alarms	<ul style="list-style-type: none">• Alarm number• Module identifier• Alarm name• Time stamp
Setpoints	<ul style="list-style-type: none">• Cool °C (or °F)• Reheat °C (or °F)
Setpoints	<ul style="list-style-type: none">• Dehumidify % RH• Humidify % RH

Press the up or down arrow key to interrupt the automatic scrolling and view a specific status screen. To return to the scrolling status screens, press the ESC key from the main menu screen.

Main menu screen

On any top-level status screen, press the ENTER or ESC key to open the main menu screen.



Note: If the display interface is inactive for ten minutes (the default delay), it will return to the scrolling status screens. To change this delay, use the **Time-out** setting under the **Password** menu.

Navigating the interface

Selector arrows. Press the up or down arrow key to move the selector arrow ❶ to a menu option or setting. Press the ENTER key to view the selected screen or modify the setting.

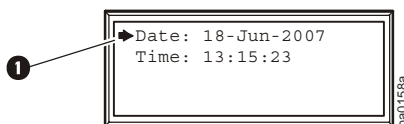

Continue arrows. Continue arrows ❷ indicate that additional options or settings are available on a menu or status screen. Press the up or down arrow key to view the additional items.

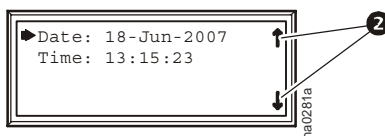

Input arrows. Input arrows ❸ next to a selected setting indicate that the setting can be modified by pressing the up or down arrow key. Press the ENTER key to save the change or the ESC key to cancel the change.

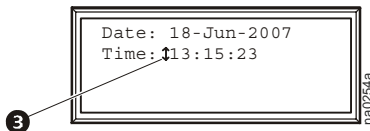

Password entry

The Module has two levels of password protection:

- **User password** for users who need to change basic and environmental settings
- **Service password** for users who need to change advanced options or modify settings that control the components in the Module

When you try to change any of the settings, the display prompts you to enter your password.

The default value for both the **User** and **Service** password is **APC** (upper case). To enter your password, use the up or down arrow keys to scroll through the alphabet. At the desired letter, press the ENTER key to select the letter and move the cursor to the next letter position. After selecting the last letter of your password, press the ENTER key once more to submit your password.

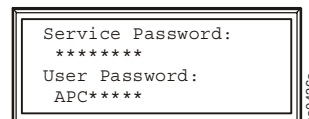

Note: Passwords are case-sensitive.

Start the System

Path: Main Menu > On/Off

To start the System, select the **On/Off** option on the main menu and change the setting to **On**. The System will run according to the current settings under **Control Environment**.

Change settings

To change a setting, use the up or down arrow keys to move the selector arrow to the setting, and press the ENTER key.

List of choices. If the setting is a list of choices, an input arrow is displayed next to the setting. Press the up or down arrow key to make your selection. Press the ENTER key to save the setting and exit from input mode. Press the ESC key to exit without saving.

Numbers or text fields. If the setting is a number or text field, use the arrow keys to select the value for the first character, and press the ENTER key to move to the next character position. Repeat this procedure to select and set each character. After the last character is set, press the ENTER key to save the setting and exit from input mode. Press the ESC key to exit without saving.

Stop the System

Path: Main Menu > On/Off

To stop the System, select the **On/Off** option on the main menu and change the setting to **Off**.



Note: Change the setting to **Off** to shut down all modes of operation and the blower fan; the display interface and the controller will continue to receive power.

For Systems with electric reheat, the blower fans may continue to operate for up to 60 seconds to purge heat from the System.

Factory default settings

All Module settings are controlled through the display interface on the front of the Main Module for each System. The factory default temperature is set at 22.2°C (72°F) in the cooling mode, and 20°C (68°F) in the reheat mode. The default deadband is set at 1.1°C (2°F).

Commissioning

After installation, verify that all components are working properly and that the Module is ready to begin operation. Before you commission the Module, make sure that the following inspections are completed:

- Initial
- Electrical
- Mechanical
- User interface

After these inspections are complete, the Module is ready for the functional test and charging. Complete the following procedures to begin operation of the Module:

- Functional test
- Module charging

After you complete the following two checklists, the Module is ready to begin normal operation:

- Start-up
- Final



Electrical Hazard: Perform Lockout/Tagout procedures on the equipment being serviced. Failure to remove power before servicing this equipment could result in serious injury or death.

The initial inspection ensures that the Module has been securely mounted to the floor stand or sub-base and that the air distribution system is properly installed. The room must be sealed with a vapor barrier and the Module must be free of damage.

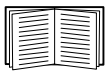

To perform the inspection, see “Initial Inspection Checklist” on page 11.



Caution: Do not run service utilities in front of the blower outlets.



Caution: The vapor barrier minimizes moisture infiltration. Without a vapor barrier, your equipment will have difficulty maintaining the humidity in the room.

Do not introduce unconditioned outside air into the space.



Note: 914 mm (36 in) of clear floor space in front of the equipment is required for service access.

Electrical inspection. The electrical inspection verifies that all electrical connections are secure and correct and that the Module is properly grounded.

Power On/Off Procedure

Power on

1. Turn utility power on.
2. Set each main breaker located behind the left door to the “1” (ON) position by pushing each breaker lever to the left.



Note: The main breakers may be in the trip position (visible yellow indication) due to a previous power off. Reset the breakers by pushing the levers first to the right (off) then to the left (on).



Note: Wait approximately 30 seconds for the system to start.

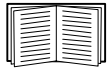

See “Start the System” on page 8 for system startup procedure.



Note: If power is lost, the system will continue in the last selected mode when power returns. No action is required.

Power off

1. Stop the System.

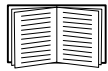

See “Stop the System” on page 8.

2. Push the red power interrupt button on the left front door.
3. Turn utility power off.

Commissioning Checklists

Initial Inspection Checklist



Warning: Review the safety and data sheet (MSDS-Material Safety Data Sheet) for R-22 for safe handling of the refrigerant.

The equipment operates under pressure — 276-2930 kPa (40-425 psi). Take proper safety precautions when connecting gauges or servicing the refrigerant/condenser loop or chilled water piping.

Never operate this equipment with any cover, guard, door, or panel removed unless instructions indicate otherwise and do so using extreme caution.



Electrical Hazard: Perform Lockout/Tagout procedures on the equipment being serviced. Failure to remove power before servicing this equipment could result in serious injury or death.



Caution: Do not run service utilities in front of the fan outlets.



Caution: The vapor barrier minimizes moisture infiltration. Without a vapor barrier, it will be difficult to maintain the humidity in the room.
Do not introduce unconditioned outside air into the space.

Ensure that:

-
- The installation procedure is complete according to the installation manual.

 - Walls, floor, and ceiling are sealed with vapor barrier.

 - Raised floor space (downflow only) beneath the equipment is a minimum of 18 in (457 mm).

 - Optional floorstands are installed correctly and that the equipment is secured to them.

 - Duct work is properly installed.

 - The equipment shows no signs of damage.

 - Clearance around the system is in accordance with ASHRAE, local and national codes and the installation manual.

 - Shipped components (leak detection devices, firestats, smoke detectors, remote sensors, etc.) are installed securely.

 - Any optional remote temperature and humidity probes installed are supported by the NetworkAIR FM DX.
-

Electrical Inspection Checklist



Electrical Hazard: All electrical wiring must comply with national and local codes. The equipment must be grounded to an earth ground (do not use a water-pipe ground). Three-phase electrical service is required.

Ensure that:

-
- Incoming voltages match the phase and voltage listing on the nameplate.

 - The equipment is properly grounded.

 - Internal electrical components and terminal blocks do not have any loose connections.

 - Electrical connections are tight, including: contactors, terminal blocks, circuit breakers, controllers, switches, relays, auxiliary devices, and field connections.

 - Circuit breakers are correct and securely attached to the DIN rail.

 - Interconnecting control wiring from the equipment to the outdoor heat exchanger/pump is correct.

Mechanical and Refrigeration Inspection Checklist

Ensure that:

-
- Condenser fans and blowers are turning freely and that the blades are not distorted or bent.

 - Condensate drain line is at least the size of the drain connection.

 - Condensate drain line is pitched (10 mm/m, 1/8 in/foot minimum) and properly trapped (100-130 mm, 4-5 in).

 - Humidifier water-supply piping is connected and is the correct size.

 - Mechanical connections are tight, including compressor roto-lock connections and the receiver roto-lock connections. Also check that the humidifier cylinders are seated on the fill/drain block.

Mechanical Inspection: Air-cooled Checklist



Warning: Air-cooled equipment is shipped from the factory with a nitrogen holding charge. Remove the nitrogen holding charge using the multiple Schrader valves located on the internal refrigerant piping.



Caution: Do not block air distribution (fan discharge openings) with field-installed piping. Failure to properly install piping and traps may result in improper operation and poor oil return through the refrigerant piping system.

Ensure that:

-
- Refrigerant piping size is correct according to the line-size table in the installation manual.

 - Vertical, horizontal, and total run lengths are recorded for liquid and discharge lines .

 - Number of 45- and 90-degree ells in the refrigerant piping are recorded.

 - Field-installed traps and piping are in accordance with the installation manual and follow proper piping practices.

 - Refrigerant piping is adequately supported and isolated when necessary.

 - Field-installed service valves are open.

 - Relief valves are installed in accordance with the installation manual.

 - Piping in the building and on the roof is properly insulated.
-

User Interface Box Inspection Checklist

Ensure that:

-
- System CAN bus is connected to each System, Main Module, and Expansion Module.

 - OHE interlock is connected.

 - Input contacts and output relays are connected correctly.

 - Module CAN bus is connected to each PCIOM board.

 - Building management system RS-485 port is connected properly (if connecting to a building management system).
-

Start-up Inspection Checklist

While the equipment is operating, ensure that:

-
- The sight glass moisture sensor is green.
-
- The current draw of all fan motors, heaters, compressors, humidifiers, transformers, and fans for each mode of operation (cool, reheat, dehumidify, humidify) are within the ratings of their circuit breaker.
 1. Record the current at the main power connection of the main circuit breaker.
 2. Record all current draws on the load side of any circuit breakers used for each device.
 3. Compare the circuit breaker setting for each device to the actual current measured and the full load amps of the device to verify that the current draws are acceptable.
-
- Compressor suction and discharge pressures are recorded.
-
- Superheat and sub-cooling temperatures are recorded.
-
- The equipment is free from malfunctions, including refrigeration leaks, unusual vibrations, or other irregularities in each mode of operation.
-
- The low pressure switch is operating correctly.
 1. Disconnect power to the liquid line solenoid at the wiring harness connector.
 2. Record the low-pressure shutoff point with a manifold.
 3. Reconnect the wiring harness to the solenoid.
-
- The high-pressure switch is operating correctly.
 1. Shut down the condenser.
 2. The head-pressure will rise until the high-pressure switch shuts down the compressor.
 3. Record the shutoff point.
 4. Restore power to the condenser.
 5. Manually reset the high head pressure switch.
-
- The cool, reheat, dehumidification, and humidification cycles engage.
-
- Filters are clean and free of debris.
-
- The clogged filter alarm is operating properly.
 1. Cover 2/3 of the filter area.
 2. Check the display interface for a **Filter Clogged** alarm condition
-
- Setpoints for the following are recorded:
 - Condenser fan minimum starting pressure.
 - Condenser fan speed control operating range.
-

Final Inspection Checklist

Ensure that:

-
- The system interior and exterior are clean and free from debris.

 - Installed options (smoke detectors, firestat, water detector, remote sensor, remote relay shutdown, dry contact alarm, essential/non-essential lockout, Redundant Unit Group control, condensate pump, etc.) are operating correctly.

 - Setpoints and deadbands are set.

 - Packaging materials are disposed of properly.

 - You have sent the start-up form to APC.

Owner Acceptance

To ensure proper unit operation and trouble free operation the following procedures must be completed and filed with the customer for future reference.

- Review installation of the equipment. Verify that installation is in compliance with Installation manual instructions/recommendations.
- Complete start-up checklist and file with owner and factory to activate warranty policy.
- Train personnel responsible for maintenance and minor adjustments to temperature & humidity set points.
- Recommend spare parts for the owner to keep on hand, especially for critical operation installations.
- Offer a list of contacts for service, technical assistance, replacement parts.

System Configuration

The System configuration options are defined both at the factory and during the commissioning of the Modules in the System.



Caution: Changing the settings incorrectly can cause serious malfunctions and damage to your System. Only qualified service personnel should make changes to these settings.



Note: Some System configuration settings may not apply to your APC NetworkAIR FM DX Precision Air Conditioner.

System options

Path: Main > Setup > System # > System Config > System Options

The **System Options** menu contains settings that identify the hardware installed in this System and the methods used to control that hardware.

Mains In. Indicates the primary operating voltage required for this System. The configuration is based on the voltage of the electrical components in the System and is printed on the nameplate attached to the door on the right side of the electrical box.

Coil Cfg. Indicates the coil configuration installed in the Modules of this System.

- **DX**—Direct expansion (DX) coil
- **Econ**—Economizer and DX coils
- **MultiCool**—MultiCool[®] (chilled water) and DX coils

Humid Ctrl. Indicates the humidity control method. The System can control the humidity based on the relative humidity (**RH**) of the return air and the dew point (**DewPt**) of the return air.

- Relative humidity (**RH**): The System activates humidification modes based on the difference between the humidify/dehumidify setpoint and the return humidity value.
- Dew point (**DewPt**): The dew point method corrects for hotspots near the environmental sensors, and is calculated from the temperature and relative humidity of the room air.
 - The System activates humidification based on the dew point setpoint and the calculated dew point in the room.
 - The dew point setpoint is calculated from the humidification setpoint and the reheat setpoint. If there is no reheat mode, then the cooling setpoint is used.

Example. If the reheat setpoint is 20°C (68°F) and the humidification setpoint is 50%, the dew point setpoint is 27°C (80°F). If the room temperature is 23°C (74°F) and the return humidity is 40% the dew point of the room is 26°C (78°F).

The humidifier demand is calculated as the difference between the actual room dew point and the desired room dew point divided by the sensitivity.

In this example: Demand = $(49 - 48) / 2 = 0.5$ or 50% demand. The humidifier output will be about 50%.



Note: The System will always use the dew point method when the remote sensor readings are used to control the room environment or if the System is part of a redundant Group.

PCIOMs. Set the number of Programmable Customer Input/Output Modules (PCIOMs) installed in the user interface box. This setting controls the number of input contacts and output relays available in the **Input/Output** menu.



See “Contacts and Relays” on page 25 to set up the contacts and relays from the display interface.

See the *NetworkAIR FM DX 60 Hz Installation* manual to connect the contacts and relays to the Main Module.

Modules in Sys. Indicates the number of Modules in this System. Up to three Modules can be joined together to work as a single System.

Air Filter. Set the type of air filters installed in the Modules of this System to either standard (30-40%) or high efficiency (65-85%).

Fast Startup. Set the System to bypass the normal start-up sequence and start-up delay the next time power is applied to the System.



Note: The **Fast Startup** option is not recommended for typical installations.

Airflow. Set the airflow pattern for the Modules in this System.

- Up
- Down

Rej. Method. Indicates the method used for heat rejection by the refrigeration system.

- Air
- Water
- Glycol

Dehum Capacity. The dehumidify mode can be set to use half capacity or full capacity of the cooling coil.

- Half capacity uses one compressor and half of the cooling coil to dehumidify. Rooms with small heat loads should use half capacity to avoid over-cooling while dehumidifying.
- Full capacity uses the entire coil and both compressors.

When the unit is in dehumidification mode the dehumidification solenoid valve on the secondary liquid line is not energized and remains closed. All refrigerant is directed through the expansion valve which feeds three quarters of the cooling coil.

Module Rot. The System rotates the order in which the compressors are engaged to equalize the total number of hours that each compressor runs. Set the number of hours at which to change the order in which the compressors are engaged. A setting of zero indicates that the order in which the compressors are engaged should not be changed.

Refrigerant. Set to the type of refrigerant charge used in the direct expansion refrigeration system..

Suction Pressure Compensation. Allows the System to slow the blowers if the suction pressure gets too high. Use this setting if you are using the FM in a high-density application.

System delays

Path: Main > Setup > System # > System Config > System Delays

The System Delays protect the Modules in the System from excessive wear and damage and keep the modes (cooling, reheat, and dehumidify) from working against each other.

Comp Min ON. The delay begins when the compressor engages and then prevents the compressor from disengaging until the delay has expired. It protects the compressors from rapidly cycling between on and off and pushing all of their lubricating oil out into the refrigerant line.



Caution: Reducing the **Comp Min ON** delay can shorten the compressor life by causing excessive wear and damage.

Comp Min OFF. The delay begins when the compressor disengages and then prevents the compressor from engaging until the delay has expired. It protects the compressors from rapidly cycling between on and off and pushing all of their lubricating oil out into the refrigerant line.



Caution: Reducing the **Comp Min OFF** delay can shorten the compressor life by causing excessive wear and damage.

Cndsr Vlv Dly. The condenser fluid valve close delay begins when the compressors disengage, and then keeps coolant flowing through the heat exchanger until the delay expires. Once the delay expires, the condenser fluid valve closes.

Intrstg Dly. The interstage delay begins when the first compressor (stage 1) in a Module engages. It prevents a second compressor (stage 2) in a System from engaging until the delay has expired.

Start-up Dly. The start-up delay begins when the System is started and initialized. The System cannot begin operation until this delay has expired. Use the start-up delay to restart equipment sequentially in your room after a power loss.

Mode Dly. The start-up delay begins when the blowers start. It allows the sensors to obtain an accurate reading of the room conditions and it allows the System to check for major alarms before engaging environmental control functions.

Communication Loss Shutdown Delay. Set the communication loss shutdown delay. The delay begins when an Expansion Module loses communication with the Main Module of a System. If communication is not restored before the delay expires, the Expansion Module will shut down. Set the delay for up to twenty-four hours, or set the Expansion Modules to continue operating if communication with the Main Module is lost by selecting **Disabled**.

Building management

Path: Main > Setup > System # > System Config > Building Management

If you are using a building management system with your Module, you must set the following values:

Address. The address of the Main Module on the RS-485 bus.

Baud Rate. The baud rate for the RS-485 bus.

Parity. The parity for the RS-485 bus.

Stop Bits. The stop bits for the RS-485 bus.



See the *NetworkAIR FM DX 60 Hz Installation* manual to wire the electrical connections of the building management system to the RS-485 bus of the Module.

Sensor setup

Path: Main > Setup > System # > System Config > Sensor Setup

Specify the set of sensors the Module will use to calculate the environmental control demands.

Temp/Hum Snsrs. Choose the set of temperature and humidity sensors the controller will use when determining the need for environmental control. The return sensors and the remote sensor string are available.



Note: Any optional remote temperature and humidity probes installed must be supported by the NetworkAIR FM DX.

Dflt Snsrs. Choose the sensor group that the System will use when the System settings are reset to their default values.

Rmt Snsr Data. When determining the environmental controls, choose the measurement from the remote sensors for the controller to use.

- **Max**—Use the maximum value reported by a sensor on the string.
- **Avg**—Use the average reported values of all of the sensors on the string.

Settings for fluid-cooled options

Modules using the Economizer or MultiCool options have several settings that must be defined. To accommodate the heat of the rejection method, the valve and piping settings must be configured.

The following table lists the settings that apply to each type of fluid-cooled option. Refer to the rest of this section for detailed descriptions of each setting:

Fluid-Coil Type	Applicable Settings
MultiCool	<ul style="list-style-type: none">• Reject Method• Coil Cfg (System Configuration)• Coil Fluid Valve• Coil Fluid Valve Actuator• Cndsr Vlv (Water and Glycol only)• Condenser Valve Actuator (Water and Glycol only)• Coil Fluid Temp Activation• Threshold• Deadband
Economizer	<ul style="list-style-type: none">• Rej Method (System Configuration)• Coil Cfg (System Configuration)• Condenser Valve• Condenser Valve Actuator (always floating control)• Coil Fluid Valve (always 3-way)• Coil Fluid Valve Actuator• Coil Fluid Temp Activation• Threshold• Deadband• Econ Isolator Valve (optional)• Econ Isolator Valve Delay: Open (optional)• Econ Isolator Valve Delay: Closed (optional)• Set an output relay to Econ Isolator (optional)

Valve types

Path: Main > Setup > System # > System Config > Valve Types

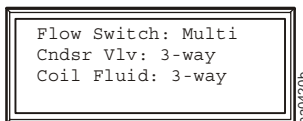

Flow Switch. Set the location of the optional flow switch in this System. The flow switch detects if there is adequate liquid coolant (glycol or water) flow to maintain coil operation.

If the flow switch detects inadequate flow in a MultiCool or Economizer coil, it will switch the cool or dehumidify mode to the direct expansion coil. If the flow switch detects inadequate coolant flow at the heat exchanger it will disable the compressors.

The **Flow Switch** setting indicates where the flow switch is installed:

- **DX**—for the water or glycol line entering the heat exchanger (to maintain head pressure in DX Systems).
- **Multi**—for the chilled water input to the MultiCool coil or chilled water coil (Systems using chilled water only).
- **None**—for air-cooled Modules with no MultiCool coil.

Cndsr Vlv. The condenser fluid valve controls the flow of coolant into the heat exchanger or to the Economizer coil. Set the condenser fluid valve as a three-way valve.



Note: Economizer valves are always three-way valves.

Coil Fluid. The coil fluid valve controls the flow of coolant to either the MultiCool, Chilled Water, or Economizer coil. Set the coil fluid valve as a three-way valve.

Actuator types

Path: Main > Setup > System # > System Config > Actuator Types

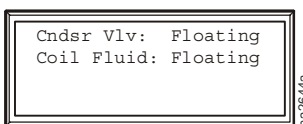

Cndsr Vlv. Set the type of condenser valve actuator; the actuator can be set as **Flt Ctrl** or **None**.

- **Floating Control** maintains the position of the valve when the power is off.
- **None** indicates that no condenser valve is installed. Air-cooled Systems with no external water piping do not require a condenser valve actuator.

Coil Fluid. Set the coil fluid valve actuator to **Flt Ctrl**, or **None**.

- **Floating Control** maintains the position of the valve when the power is off.
- **None** indicates that the Module does not have a MultiCool or Economizer coil.

Economizer isolation valve (optional)

When multiple Modules having three-way valves are connected to a common coolant source, coolant flow through a Module exists even when there is no cooling demand. The Economizer (coolant) isolation valve is used in these instances to stop coolant flow through a Module during times of no cooling demand in applications where a variable speed coolant pump is used.

- **Econ Isolator Close Dly**
- **Econ Isolator Open Dly**
- **Econ Isolator Valve Enable**
- **Econ Isolator**— mapped to an output relay

Path: Main > Setup > System # > System Config > System Delays

Econ Isolator Valve Delay: Close. When there is no longer a demand for cooling, the Economizer isolation valve actuator closes the valve. The valve remains open during the close delay, keeping coolant flowing through the coil and the heat exchanger until the delay expires.

Econ Isolator Valve Delay: Open. When there is a demand for cooling, the Economizer isolation valve actuator opens the valve. The compressors will not engage until the open delay has elapsed.



Note: If you are using different types of actuators for the Modules in your System, set the open delay to accommodate the valve that takes the longest to open.

Path: Main > Setup > System # > System Config > Coil Fluid Options

Econ Isolator Valve: Enable. Use this setting to indicate that an Economizer isolation valve is installed in the coolant piping for this System.

Path: Main > Setup > System # > Input/Output > Output Relays

Econ Isolator Output Relay. To use the Economizer isolation valve, you must map the **ECON ISOLATOR** event to one of the output relays. When you set up the relay for the Main Module, it will copy the settings to the Expansion Modules.



You must set an output relay to activate the Economizer isolation valve. See “Output relays” on page 27 for instructions on how to set up the relay.

Coil fluid temperature activation threshold and deadband

Path: Main > Setup > System # > System Config > Coil Fluid Options

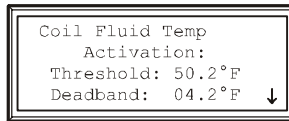

The **Coil Fluid Options** help control the optional MultiCool coil or Economizer coil in equipped Systems. Set the temperature threshold and deadband for using the MultiCool coil or the Economizer coil. The System will compare the actual coolant temperature with the setpoint and deadband to determine if the coolant is at a temperature low enough to operate the coils.

Coil Fluid Temp Activation: Threshold. Set the coil fluid activation threshold. The coolant temperature must be below the threshold to use the optional MultiCool coil or Economizer coil.

Coil Fluid Temp Activation: Deadband. Set the MultiCool or Economizer activation deadband. The deadband is the sensitivity range above the **Coil Fluid Temp Activation: Threshold** that the coolant temperature can reach before the controller will stop using the MultiCool or Economizer coil. For example, if the threshold is 10°C (50°F) and the deadband is 2.2°C (4°F), then the controller will disengage the MultiCool coil or Economizer coil when the coolant temperature exceeds 12.2°C (54°F) and will not reengage the coil until the coolant temperature reaches 10°C (50°F).

Contacts and Relays

The System can monitor external contact closure events for the following applications:

- Magnetic contact switches
- Window foil
- Tamper switches
- Heat detectors
- Water sensors
- Pressure sensors
- Building smoke and fire detection systems

You can set input contacts to cause alarm conditions based on their current state and a user-defined normal state. Output contacts can map internal alarms and events to outside devices.



See the *NetworkAIR FM DX 60 Hz Installation* manual for instructions on connecting contacts and relays to your Programmable Customer Input/Output Module (PCIOM).

Input contacts

Path: Main > Setup > System # > Input/Output > Input Contacts

Input: 01of16
Name: Input1
Normal: Open
Status: Open

na0423a ↓

Delay: 030 s
Action:
Major Alarm

na0424a ↑

Each Main Module supports up to 16 user-defined input contacts. Each contact monitors a sensor and responds to changes in the state of the sensor (open or closed).

Name. Provide a unique name for each input contact.

Normal. Choose the normal state of the sensor. If the state changes, the controller takes the action defined by the **Alarm Map** setting.

Delay. Set how long the contact should be out of its normal state before the controller takes action (controlled by the **Alarm Map** setting).

Action. Set the System controller to respond to the change of status for an input in one of the following ways:

Map	Description/Function
Status Only	Displays the event on the Active Alarms screen. Status-only events are not logged.
Minor Alarm	Activates the Warning LED and the alarm beeper. It also creates an entry in the event log.
Major Alarm	Activates the Alarm LED and the alarm beeper. It also creates an entry in the event log.
Remote Run/Stop	Shuts down the Modules normally, waiting for delay timers.
Nonessential Lockout	Deactivates modes set as nonessential and continues operation.
Immediate Shutdown	Shuts down the Modules immediately. It does not wait for the blower delay or compressor timers.

Output relays

Path: Main >Setup >System # >Input/Output >Output Relays

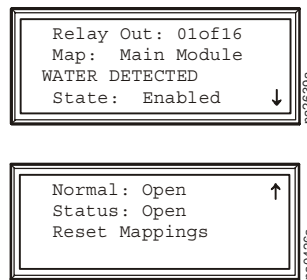

The Main Module supports up to 16 user-defined output relays. Output relays respond to internal alarms and events by changing states to notify outside devices.

Relay Out. Choose the relay number to view or modify.

Map. Choose alarms or events to map to this relay:

- The first line of the map field displays the location of the event that is mapped to this relay. It can be a System, Main Module, Expansion Module 1, or Expansion Module 2 event.
- The second line displays the name of the event mapped to this relay.



Note: Any input contact or output relay available in this System can be mapped to this relay.

If you have installed an Economizer automatic coolant isolation valve (**Econ Isolator**), you need to map the **Econ Isolator** event to a relay connected to the isolation valve actuator.



Caution: When using the Economizer automatic isolation valve, map only the **Econ Isolator** event to the relay connected to the valve actuator.



See the *NetworkAIR FM DX 60 Hz Installation* manual for instructions on wiring the relay connection to the automatic isolation valve actuator.

Action. The **Action** field changes as you scroll through the list of events that can be mapped to this relay. **Remove** indicates that the event is already associated with this relay. **Add** indicates that the event is not associated with this relay. Press the ENTER key and change the setting to map the displayed event to this relay or remove the displayed event from the list of events mapped to this relay.

Normal. Set the normal state for this relay. If the state of an alarm or event mapped to this relay changes from the normal state, the relay also changes state.

Reset Mappings. Clear all of the output mappings back to their default setting.

Module Configuration

The Module configuration settings define which components are available and how the Module should operate.



Caution: The settings in the Module Configuration menu are defined at the factory. Changing the settings incorrectly can cause serious malfunctions and damage to your System. Only qualified service personnel should make changes to these settings.

Configure Module

Paths: Main > Setup > Module > Main Module > Module Config > Config Module
Main > Setup > Module > Expansion Module 1 > Module Config > Config Module

The **Config Module** menu settings define the optional equipment available in the Module.

- **Output Cap** – Indicates the output capacity of the Module, in kilowatts.
- **Heater** – Indicates the type of heating equipment installed to run the reheat mode.
- **Humid** – Indicates the type of humidifier equipment installed to run the humidification mode.
- **Conds Pump** – Indicates the presence of a condensate pump. The pump feeds the condensate from the reservoir into the drain.
- **Blower** – Indicates the type of blower controller for this Module.
- **ElecHeater Cap** – Indicates the capacity of the electric heater.

Alarm detectors

Paths: Main > Setup > Module > Main Module > Module Config > Set Alarm Detectors
Main > Setup > Module > Expansion Module 1 > Module Config > Set Alarm Detectors

The **Set Alarm Detectors** settings indicate the presence of sensors in the Modules.

- **Smoke** – Indicates whether a smoke detector is installed in the Module.
- **Fire** – Indicates whether a fire detector (thermal sensor) is installed in the Module.



Note: Thermal sensors for fire detection are not intended for personnel safety. The devices are intended to supplement, not replace, building fire detection systems.

- **Water** – Indicates whether water leak detectors (loop detectors) are installed in the Module.

Module Control

The Module Control options are configured and tuned during the commissioning of each Module.



Caution: The settings in the Module Control menu are defined at the factory. Changing the settings incorrectly can cause serious malfunctions and damage to your System. Only qualified service personnel should make changes to these settings.

Calibrate airflow manually



Note: The System must be on and the blowers must be operating to calibrate the airflow manually. If either condition does not exist, the display will prompt you to turn on the System and blowers.

Nom Coil DP. Set the nominal coil differential pressure.

Blower Spd. Adjust the frequency of the blower.

Coil DP. Displays the coil differential pressure. The coil differential pressure changes as the blower frequency is adjusted. The Std Dry value in the table below gives the recommended coil differential pressure for the FM DX Precision Air Conditioner.

Coil Differential Pressure Values					
Downflow DX only	Coil dP (in WC)	0.43	0.49	0.55	0.62
	SCFM	7600	8100	8600*	9100
Downflow Multi/Econ	Coil dP (in WC)	0.59	0.67	0.76	0.86
	SCFM	7100	7600	8100*	8600
Upflow DX only	Coil dP (in WC)	0.32	0.36	0.41	0.46
	SCFM	7600	8100	8600*	9100

* Indicates Standard Dry nominal point

Calibrate airflow automatically

Nom Coil DP. Set the nominal coil differential pressure.

Start/Abort. Start the automatic calibration. If calibration is in progress, this line displays: **Abort.**

Coil DP. Displays the coil differential pressure. The coil differential pressure changes as the blower frequency is adjusted. When the **Coil DP** values match the **Nom Coil DP** value, the System will display **Calibration Complete**. If the System cannot align the two values, the System will display **Calibration Failed** after two minutes. You must manually calibrate the airflow if automatic calibration fails.

Reset Variable Frequency Drive

Paths: Main > Setup > Module > Main Module > Module Control > Reset VFD#
Main > Setup > Module > Expansion Module 1 > Module Control > Reset VFD#

The **Reset VFD** option resets the variable frequency drive (VFD). The drive shuts down during a **VFD # Fault Tolerance Exceeded** alarm. The alarm occurs when the VFD detects three faults within thirty minutes. Use this function to restart the drive manually when the alarm condition is resolved.



Caution: VFD Fault Tolerance Exceeded alarms indicate a problem with the VFD or blowers. Check the event log for other alarms before resetting the VFD.

Reset humidifier

Paths: Main > Setup > Module > Main Module > Module Control > Reset Humidifier
Main > Setup > Module > Expansion Module 1 > Module Control > Reset Humidifier

The **Reset Humidifier** option resets the humidifier. The humidifier shuts down during a **Humidifier Fault Tolerance Exceeded** alarm. The alarm occurs when the humidifier detects three faults within thirty minutes. Use this function to restart the humidifier manually when the alarm condition is resolved.



Caution: Humidifier Fault Tolerance Exceeded alarms indicate a problem with the humidifier. Check the event log for other humidifier alarms before resetting the humidifier.

Set up humidifier

Paths: Main > Setup > Module > Main Module > Module Control > Set Up Humidifier
Main > Setup > Module > Expansion Module 1 > Module Control > Set Up Humidifier

The **Set up Humidifier** option controls the steam-electrode humidifier mode.

Humidifier Model. The steam-electrode humidifier can be set to one of three modes:

- **Off**—Removes power from the electrodes in the humidifier while the cylinder remains filled.
- **Drain**—Removes power from the electrodes and drains the cylinder.
- **Auto**—Applies power to the humidifier and sets the humidifier to operate according to the Module controller.



Note: The steam-electrode humidifier must be in **Auto** mode to operate.

Control the Environment

The System controls the room environment by engaging one of four modes: Cool, Dehumidify, Reheat, or Humidify. These modes may work differently depending on the options and equipment installed in the Modules.



Note: The environmental controls are set when your System is installed. Making changes to the settings described in this section after the System has been commissioned may result in improper operation.

How the modes work

DX Cool. Cool mode output is determined by the difference between the setpoint and the average return air temperature of each of the Modules in the System (if more than one Module is present). The deadband is used to engage the compressors incrementally with increasing demand. Each compressor in the System is assigned an equal division of the deadband. As the average return temperature rises above the setpoint, a compressor is engaged. If the average return temperature reaches the setpoint plus the entire deadband, all of the compressors will be engaged. As the temperature drops through each increment of the deadband a compressor will be disengaged. When the temperature drops below the setpoint the remaining compressor will disengage.



See “Deadbands” on page 34 for instructions on setting the DX cool deadband.

Fluid Coil Cool. When the cool mode uses a MultiCool or Economizer coil, the output is determined by the difference between the setpoint and the average return air temperature of each of the Modules in the System (if more than one Module is present). The Proportional plus Integral plus Derivative (PID) control loop calculates the output as demand increases and opens the valve controlling the flow of coolant into the coil. As the average return temperature increases, the output will increase until it reaches 100 percent of capacity. For Modules with an Economizer coil, one stage (compressor) of DX cooling can be engaged per Module to help meet the demand. The rule for engaging the compressor is the same as for DX cool.



See “PID controls” on page 38 for a description of the PID controls and see “How to tune the PIDs” on page 38 for instructions on tuning the fluid coil PID loop.

Reheat (Electric SCR). The silicon controlled rectifier (SCR) electric reheat function is controlled by the reheat PID controller. When the return temperature of the Module drops below the reheat setpoint, the reheat output will increase as the return temperature drops until output reaches 100%.



See “PID controls” on page 38 for a description of the PID controls and see “How to tune the PIDs” on page 38 for instructions on tuning the reheat PID loop.

DX Dehumidify. Similar to DX cooling, the output for dehumidification is determined by the difference between the setpoint and the average return humidity from each of the Modules in the System (if more than one Module is present). The deadband is used to engage both compressors incrementally with increasing demand. Each Module in the System is assigned an equal division of the deadband (a percentage of relative humidity). Both compressors in a Module are engaged when the assigned division of the deadband (above the setpoint) is reached. If the average return humidity reaches the setpoint plus the entire deadband, all of the compressors will be engaged until the humidity drops below the setpoint plus the deadband. Unlike DX cooling, the compressors in each Module are normally set to work as a single unit instead of separately. The use of one or two compressors per Module is based on the **Dehum. Capacity** setting (**Path: Main Menu > Setup > System # > System Config > System Options**).



See “Deadbands” on page 34 for instructions on setting the DX dehumidify deadband.

MultiCool Dehumidify. MultiCool dehumidify mode is controlled by the dehumidify PID controller. When the return humidity rises above the setpoint, the dehumidify output increases as the return humidity rises until the output reaches 100%



See “How to tune the PIDs” on page 38 for a description of the PID controls and see “How to tune the PIDs” on page 38 for instructions on tuning the dehumidify PID loop.

Humidify. The steam cylinder humidifier output is controlled by the humidify proportional controller. When the return humidity drops below the humidify setpoint, the humidifier output will increase as the return humidity drops until the output reaches 100%.



See “Humidification sensitivity” on page 39 for a description of the Humidification sensitivity band.

Setpoints

Path: Main > Control Environment > Setpoints

Cool:	72.0°F
Reheat:	68.0°F
Dehumid:	55.0%RH
Humidify:	45.0%RH

Setpoints are the target values each mode will maintain in the room. The default setpoints are appropriate for most precision cooling applications.

The setpoint for each mode must be within the following ranges:

- Cool: 16.5–32.2°C (61.8–90.0°F)
- Reheat: 15.6–31.2°C (60.0–88.2°F)
- Dehumidify: 30–80% Relative Humidity
- Humidify: 30–80% Relative Humidity



See “Modes” on page 37 to enable or disable operating modes. If a mode is disabled and you change the setpoint, the display will warn you that the mode is disabled.



Note: You cannot overlap setpoints. If you overlap setpoints, the display interface warns you and resets the setpoints.

The **Cool** setpoint must be 1°C (1.8°F) above the **Reheat** setpoint if reheat is installed in the Module. The **Dehum** setpoint must be 1% Relative Humidity (RH) above the **Humidify** setpoint if a humidifier is installed.

Deadbands

Path: Main > Control Environment > Deadbands

Cool:	02.0°F
Reheat:	02.0°F
Dehumid:	05.0%RH

na2643a

The deadband is the sensitivity range for a setpoint. It is the value above or below the setpoint at which the mode will output at full capacity. For the DX cool and DX dehumidification modes, the compressor stages are engaged one at a time as the temperature or humidity exceeds equal portions of the deadband (above the setpoint).

Acceptable deadband ranges:

- Cool: 0.28–5.6°C (0.5–10.0°F)
- Reheat: 0.28–5.6°C (0.5–10.0°F)
- Dehumidify 1–10% Relative Humidity

Cool deadband. The **Cool** mode splits the deadband into equal segments according to the number of compressors in the System. A compressor is then assigned to each segment of the deadband above the setpoint. When the return temperature exceeds the temperature associated with that segment, the compressor engages and runs until the temperature drops below that segment.

To set the cool deadband for your System:

1. Determine the number of Modules in your System (1 – 3).
2. Multiply the number of Modules in your System by two.
3. Use this number as your cool deadband setting. This assigns each compressor a 1°F segment of the deadband above the setpoint.
4. Adjust the deadband setting higher or lower to increase or decrease the speed at which the System can respond to rising temperatures.

The following graphic is an example of a two-Module System (with four compressors). The setpoint is 21.1°C (70°F) and the deadband is 2.2°C (4°F). Each compressor engages as the return air temperature reaches its assigned segment of the deadband above the setpoint. When the return air temperature drops back below the temperature assigned to a compressor, that compressor disengages.

Cool Deadband Compressor Allocation Two-Module System

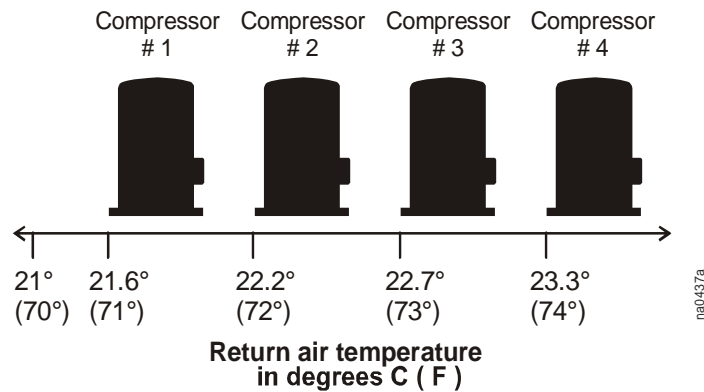

Caution: If the deadband setting is too narrow, it will cause the System to engage the compressors in response to a small temperature change. Since the compressors must run for a minimum period to avoid damage, this could over-cool the room.



Caution: If the deadband setting is too wide, the System will not engage all of its cooling capacity until the return air temperature is significantly above the setpoint.

Dehumidify deadband. The Dehumidify mode splits the deadband into equal segments according to the number of Modules in the System. A Module is then assigned to each segment of the deadband above the setpoint. When the return air relative humidity exceeds the relative humidity associated with that segment, the compressors in that Module engage and run until the relative humidity drops below that segment.

To set the dehumidify deadband for your System:

1. Determine the number of Modules in your System (1-3).
2. Multiply the number of Modules in your System by two.
3. Use this number as your dehumidify deadband setting. This assigns each Module a 2% RH segment of the deadband above the setpoint.
4. Adjust the deadband setting higher or lower to increase or decrease the speed at which the System can respond to rising relative humidity.

The following graphic is an example of a two-Module System that is using full dehumidification capacity (tandem compressors working together as one). The setpoint is 55% RH and the deadband is 4% RH. The compressors of each Module engage as the return air relative humidity reaches their segment of the deadband above the setpoint. When the return air humidity drops below the humidity assigned to them, those compressors disengage.

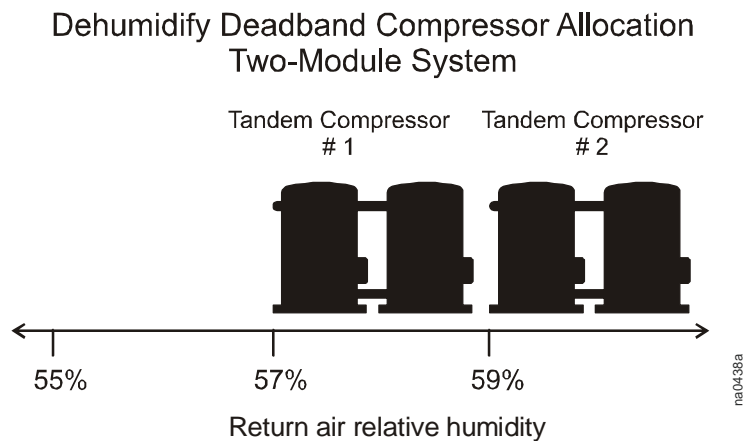

Caution: If a deadband setting is too narrow, it will cause the System to engage the compressors in response to a small humidity change. Since the compressors must run for a minimum period to avoid damage, this could overly dehumidify the room.



Caution: If a deadband setting is too wide, the System will not engage all of its dehumidification capacity until the return air humidity is significantly above the setpoint.

Modes

Path: Main > Control Environment > Modes

Cool:	Enabled
Reheat:	Disabled
Dehumid:	Enabled
Humidify:	Enabled

na0431a

Enable and disable the modes of operation. The four modes are:

- Cool
- Reheat
- Dehumidify
- Humidify

Modes can only be enabled or disabled using the service password.

Essential functions

Path: Main > Control Environment > Essential Functions

Designate each mode as either essential or nonessential. The modes marked as nonessential are disabled when an alarm or event occurs that requires all nonessential operations to be stopped (nonessential lockout).

Cool:	Essential
Reheat:	Nonessent.
Dehumid:	Nonessent.
Humidify:	Nonessent.

na0431a



See “Input contacts” on page 25 for a table with descriptions of how you can set up nonessential lockout events that occur when an input contact becomes active.

PID controls

Path: Main > Setup > System # > System Config > PID Controls

The Proportional plus Integral plus Derivative (PID) loop is used to control the output of the LiquidCool, reheat, and dehumidify modes.

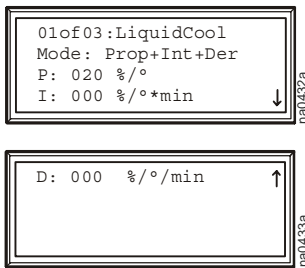

Choose which mode or actuator PID loop to tune, using the **01of03**: [Mode/Actuator name] setting.

Model. Choose the multipliers to use in the PID algorithm. You can omit the derivative or the integral and derivative multipliers in the algorithm.



Note: Controllers that use temperature as the process variable calculate the process error in units of Centigrade.

P. The proportional multiplier (gain) for this mode or actuator. The proportional multiplier adjusts for the difference (error) between the measurement (temperature or humidity) and the setpoint. The proportional multiplier is expressed in percent of output per unit of error.

I. The integral multiplier (reset rate) for this mode or actuator. The integral multiplier adjusts for error measurement and the amount of time that the error has existed. The integral multiplier adds to or subtracts from the output in small increments to correct for the offset error caused by the proportional contribution. It is expressed in percent of output for each minute and unit of error (error multiplied by minutes).

D. The derivative multiplier (derivative) for this mode or actuator. The derivative multiplier adjusts the output for rapid changes in the error, correcting for the rate of change of the error over time. It is expressed in percent of output for each unit of error per minute (error divided by minutes).

How to tune the PIDs

A qualified service technician must tune the PID loops to optimize the performance of each mode. The units shown are for temperature. In the dehumidify loop, the units are in percent relative humidity (% RH).



Caution: The PID loops must be tuned after the equipment in the room is installed and running. The loops should be tuned periodically to account for changes in the room load.

1. Select the PID loop to tune.
2. Adjust the integral and derivative constants to zero and the proportional constant to twenty.
3. Set the temperature (cool or reheat) setpoint value and start the System.
4. When the temperature reaches a stable value, increase the proportional constant by 10. If the temperature does not respond to this change, adjust the setpoint.
5. Repeat step 4 until the temperature value starts to oscillate and the peak amplitude of the oscillations is constant.

6. Note the time, in minutes, between the peaks of the oscillations. This is the Ultimate Period, P_U .
7. Note the value of the proportional constant. This is the Ultimate Gain, G_U .
8. Compute the PID constants using the table below. Select the type of control from the rows of the table and use the equations in the columns to compute the values for each constant.
9. Set each constant according to these calculations.

Control Method	Proportional	Integral	Derivative
P	$0.5 * G_U$	–	–
P + I	$0.45 * G_U$	$0.54 * G_U / P_U$	–
P + I + D	$0.6 * G_U$	$1.2 * G_U / P_U$	$0.075 * G_U * P_U$

You may need to further tune the PID loops in the following ways to account for changes in the room load:

Loop Behavior	PID Tuning Correction
Slow response to temperature/humidity changes	Decrease the proportional multiplier or increase the derivative multiplier.
Over-cooling/Under-cooling after changes in the room load or changes in setpoint	Increase the derivative or the proportional multipliers.
Environmental temperature/humidity never reaches the setpoint	Increase the integral setting.
Over-cooling/Under-cooling on constant room load	Decrease the integral multiplier.

Humidification sensitivity

Path: Main > Setup > System # > System Config > Humid. Sensitivity

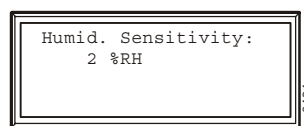

Humid. Sensitivity. The humidifier sensitivity band is the percentage of relative humidity below the humidify setpoint at which the humidifier operates at full output.

Alarms

Set alarms to alert you to abnormal temperatures or humidity levels and the number of hours the components have been in operation.



See “Respond to Alarms” on page 52 for information on how to correct these conditions. Alarms will also alert you to malfunctions; however, malfunction alarms are not user-definable.



Note: Preset alarm threshold default values are applicable for most precision air conditioning applications.

Temperature alarms

Path: Main > Setup > System # > Alarms > Temp Thrshlds

Temperature Thresholds. Set the low- and high-temperature alarms for the air at each of the following locations. When the air temperature at the sensor is outside the range defined by the thresholds, an alarm will occur.

Sply (Supply)	Temperature thresholds for the conditioned supply air.
Env (Environmental)	Thresholds for the air at the sensors that are controlling the room temperature (either the return or the remote sensors, depending on your settings).

Humidity alarms

Path: Main > Setup > System # > Alarms > Humidity Thresholds

Humidity Thresholds. Set the low and high humidity alarms for the air at each of the following locations. When the relative humidity of the air at the sensor is outside the range defined by the thresholds, an alarm will occur.

Sply	Humidity thresholds for the air blown into the room (supply air).
Rtrn	Humidity thresholds for the air drawn out of the room (return air).

Maintenance intervals

Path: Main > Setup > System # > Alarms > Maint Intervals

The display interface records the number of hours each of the eight components in each Module has operated. Set the maintenance interval for each type of component in the Modules of your System. Every time the run hours for a component in a Module elapse this number of hours, an alarm will occur. Move the selector arrow next to the component name (top line of the screen) and press the ENTER key to scroll through each of the eight components.

Component name. Scroll through the components to view the maintenance intervals:

- Blower 1
- Blower 2
- Heater
- Humidifier
- Variable Frequency Drive 1 (VFD 1)
- Variable Frequency Drive 2 (VFD 2)
- Compressor 1
- Compressor 2

Alarm. Set the number of operating hours (in 100-hour increments) at which you want an alarm to occur. Set this to remind you of maintenance milestones.

Alarm delay

Path: Main > Setup > System # > Alarms > Alarm Delays

The alarm delay is the period between start-up and the enabling of alarms. The delay allows the modes (Cool, Reheat, Dehumidify, and Humidify) to take effect before alarms occur.

Temperature Delay. Set the temperature alarm delay. The maximum delay is 999 seconds (16 minutes, 39 seconds).

Humidity Delay. Set the humidity alarm delay. The maximum delay is 999 seconds (16 minutes, 39 seconds).

Group

Up to four Systems can be connected to form a redundant Group. Joining Systems together to form a Group provides the following:

- Redundancy
- A way for other Systems in the Group to assist with the room load
- Demand fighting prevention (one System cooling while another reheats)
- System run-time balancing
- Setpoint sharing among Systems
- Alarm sharing among Systems



Note: Group settings are copied to each System in the Group.

Group configuration

Path: Main > Setup > Group > Group Config

The **Group Config** settings define the options to use in the redundant Group.

Systems. Set the number of Systems connected together to form this Group. Setting the number of Systems to 1 disables the Group functions.

Setpoint Share. Enable or disable setpoint sharing among the Systems of this Group. When setpoint sharing is enabled, changes to the cool or reheat setpoint on any System in the Group are copied to all of the other Systems.



Note: The humidify and dehumidify setpoints are always shared.

Idle Blwr Spd. Set the behavior of the blowers for Systems that are in the idle, backup, or failed states. In raised floor installations, Systems that are not active (idle, backup, or failed) should maintain blower operation to maintain static pressure and to keep cool air flowing to your data-center equipment rather than up through an idle Module.

Dmnd Fighting. When enabled, reheat is prohibited for all Systems in the Group when any System in the Group has a cooling demand. This prevents Systems from working against each other.

Grp Fire Alarm. Share fire alarms among the Systems in this Group. If the **Group Fire Alarm** setting is **On**, then all Systems in the Group will shut down if a fire alarm occurs in one System. If the **Group Fire Alarm** setting is **Off**, the alarm will still be shared with the other Systems, but they will not shut down.

Grp Smoke Alarm. Share smoke alarms among the Systems in this Group. If the **Group Smoke Alarm** setting is **On**, all Systems in the Group will shut down if a smoke alarm occurs in one System.

Comm Loss Failover. Decide if the Group considers a System in the **Comm Lost** state to be in a failed state.

- **Off**—The Group will assume that the System is still operating normally.
- **On**—A backup System will be moved to the online state.



Caution: If Runtime Balancing is enabled, Comm Loss Failover must be On. Otherwise inadvertent System shutdowns may occur.

Name. Set the name of this Group. The Group name also appears in the interfaces.

Group settings

Path: Main > Setup > Group > Group Settings

The **Group Settings** define the load-sharing and System role-assignment functions of the Group.

Load Share. Enable or disable load-sharing requests for each mode. If load-sharing is disabled, Systems cannot send requests for assistance to the Group.

Load Share Thrshlds. Set the load-sharing thresholds for each mode. If the environmental temperature or humidity is outside the range determined by the setpoint and threshold, the System will generate a load-sharing request. Acceptable ranges for each mode are listed in the table below.

Mode	Range	Share if
Cool	0.0–11.1°C (0.0–20.0°F)	Temperature > Setpoint _{Cool} + Threshold _{Cool}
Reheat	0.0–11.1°C (0.0–20.0°F)	Temperature < Setpoint _{Reheat} – Threshold _{Reheat}
Dehumidify	0.0–20.0% RH	Humidity > Setpoint _{Dehumidify} + Threshold _{Dehumidify}
Humidify	0.0–20.0% RH	Humidity < Setpoint _{Humidify} – Threshold _{Humidify}

System Role Assignment. The **System Role Assignment** settings depend on the Run-time Balance (**Run-time Bal**) setting.

- If **Run-time Bal** is set to **On**, each System is rotated between a primary and backup role in order to spread the run hours among all of the Systems in the Group. Rotation occurs when a primary system exceeds the runtime of a backup system by more than 72 hours.

Primary: Set the number of Systems to be designated as primary. The remaining Systems in the Group will assume the backup role.

- If **Run-time Bal** is set to **Off**, you must designate the role of each System in the Group. The System will retain this role until you change the setting.

Sys# Role: Set the role for each System. Back-up Systems only operate in the event of a failure or load-sharing request (if enabled).



Caution: If **Runtime Balancing** is enabled, **Comm Loss Failover** must be On. Otherwise inadvertent System shutdowns may occur.

System failure events

Path: Main > Setup > Group > Group Settings



Note: The **System Failure Events** must be configured at each System in the Group. Unlike other Group settings, the **System Failure Events** list is not copied to each System in the Group.

Configure the list of **System Failure Events**. If a System failure event occurs, the System in which it occurs transitions to the failed state, and a backup System is engaged if available.

Event. Scroll through the list of possible failure events. The first line indicates whether the event is System-level or Module-level and the second line indicates the event text.

State. Set each event to **Enabled** or **Disabled**. If an enabled event occurs in a System, that System transitions to the failed state and stops running unless there is no backup System available.

Display

Set display settings including the time and date, temperature units, passwords, and time-out settings. You can also reset settings to their default values and download new firmware.

Password and time-out

Path: Main > Setup > System > Display > Password & Time-out



Note: The default user password is **APC** (upper-case). See “Password entry” on page 7 for more information on how to enter the password.

Change passwords. Set the passwords necessary to change System settings.

1. Move the selector arrow next to the **Change Password** option and press the ENTER key.
2. Select the password to change (either **Service** or **User**).
3. Enter your current password; once this is entered, you will return to the **Change Password** screen.
4. Enter a new password (up to 8 characters).
5. Press the ENTER key to confirm.



Note: If you do not want settings to be protected by a password, enter a blank space character for the password.

Password and menu time-out. Set the time-out period during which settings can be changed after the password is entered. After the period has elapsed without a keypress, password entry will be required and the display interface will return to the scrolling status screens.

Invalidate Password. Override the password time-out delay and make password entry required again with the **Invalidate NOW** option.

Date and time

Path: Main > Setup > System > Display > Date/Time

Set the date. Enter the day, month, and year then press the ENTER key. The date is displayed on some status screens and is also used in the alarm/event log to date-stamp events.

Set the time. Enter the correct time and press the ENTER key. The time is displayed on some status screens and is also used in the alarm/event log to time-stamp events.

Temperature and pressure units

Path: Main > Setup > System > Display > Temp/Pressure Units

Temperature units. Set the units of measure for temperature readings and settings to either Fahrenheit (°F) or Celsius (°C).

Pressure units. Set the units of measure for pressure readings and settings to either English (psig) or metric (kPa).

Adjust display

Path: Main > Setup > System > Display > Display Adjust

Set the LCD contrast. Adjust the visibility of the screen text. Lower numbered settings provide darker text; higher numbers provide lighter text. Settings range from 0–7.

Key Click. Enable or disable a beep sound every time a key is pressed on the display interface.

How to update the firmware

Path: Main > Setup > System > Display > Update Firmware

To update firmware:

1. Go to www.apc.com/tools/download/ and check for the most recent version of the firmware.
2. If a newer version is available, download it to a location that can be accessed in step 5.



Caution: Stop the System before updating the firmware. For instructions, see “Stop the System” on page 8.

3. Set up the serial connection:
 - a. Connect an available serial port of your computer to the DB-9 serial port on the electrical panel, using the supplied serial cable (APC part number 940-0103). To extend the cable, use APC cable number 940-1000A with 940-0103.
 - b. Run a terminal emulation program, such as HyperTerminal®.
 - c. Configure the following settings on the serial port you selected:

Baud Rate	19200
Data Bits	8
Parity	None
Stop Bits	1
Flow Control	None



Note: Some terminal emulation programs require that you disconnect and then reconnect the terminal session for the new serial port settings to take effect.

4. On the display interface, select **YES** from the **Update Firmware** menu. Use the path you selected in step 2.
5. In your terminal emulator, ensure that the connection is active (HyperTerminal will display a series of “C” characters) and send the file using the XMODEM protocol.
6. When the download is complete, the screen displays the new version.
7. Restart the System.

Reset to defaults

Path: Main > Setup > System # > Display > Reset to Defaults

Reset User Parameters. Return settings that can be modified with the user password to their factory default settings.

Reset Srvc Parameters. Return settings that can be modified with the service password to their factory default settings.

Reset Group Parameters. Return Group settings that can be modified with the service password to their factory default settings.

Reset Controller. Turn off the Module and then restart it for service purposes.



Caution: The Module will not cool for several minutes during the restart process. Only trained field service personnel should use this feature.

Product data

Path: Main > Setup > System # > Display > Product Data

The **Product Data** option provides three screens of user-defined data that make identifying information available at the display interface.

These options are on the **Product Data** screens:

- Product Name
- Product Location
- Product Contact



See “Password entry” on page 7 for instructions on entering text at the display interface.

Network Configuration

Configure the network settings for the Network Management Card from the display interface. The management card allows remote control and configuration of the System.

Network configuration

Path: Main > Setup > System # > Network Config

MAC Address. Displays the unique network identifier assigned to each Network Management Card at the factory.

Mode. Set the method by which the Network Management Card for the System will acquire its network settings:

- **Manual**—Scroll down and enter the network settings for the Network Management Card.
- **BOOTP**—Set the Network Management Card to obtain its network settings from a BOOTP server.
- **DHCP**— Set the Network Management Card to obtain its network settings from a DHCP server.

IP. Set the IP address assigned to the Network Management Card (manual mode only).

MSK. Set the subnet mask for the Network Management Card (manual mode only).

GW. Set the default gateway for the Network Management Card Network Management Card(manual mode only).

Accept Changes. You must select **Accept Changes** to save any modifications to the IP address, subnet mask, or default gateway.

View Status Readings

The display interface has several options for viewing the status of the System, its Modules, and the environment being controlled. The status readings for Modules are available under the **Main Module** and **Expansion Module #** options, and status readings for the System are available under the **System Status** option or on the scrolling status screens.



Note: Only the Main Module of a System has a display interface. Return temperature and humidity readings displayed on the scrolling status screens are an average of the readings from each of the Modules.

If the System is off, the readings will be the values from the sensors of the Main Module.

Scrolling status screens

When the display interface is idle, it scrolls through nine screens of status information. Press the up or down arrow key to interrupt the automatic scrolling and view a specific status screen.

Module status

Paths: Main > Status > Main Module

Main > Status > Expansion Module 1

The Module status screens contain information for each Module in a System.

Temp & Humidity. View temperature and humidity readings at the supply, return, and remote sensors for each Module. This screen has the same format as the **Temp & Humidity** scrolling status screen, but the values displayed are only for the selected Module.

Pressures. View the differential pressures at the coil and the filter for this Module.

Run hours. View the total time each component has been running.

- **Clear Total:** Reset the run hours for the displayed component to zero.
- **Reset Maint Alarms:** Clear the maintenance alarm for the displayed component. The alarm will occur when the run hours reach the next maintenance interval.



See “Maintenance intervals” on page 40 for instructions on scrolling and clearing the total hours.

About Module. View identifying information that is helpful when obtaining service:

- Manufacturer Name
- Model Number
- Date of Manufacture
- Serial Number
- Firmware Revision
- Hardware Revision

Humidifier Status. View the humidifier output, the amount of current drawn by the humidifier, and the conductivity of the water in the humidifier cylinder in this Module.

Water Temps. View the coil fluid inlet temperatures for the coolant.

Blower [#] Status. View the status of blower 1 and blower 2 and the variable frequency drives that control the blowers.

Compressor Status. View the suction and discharge pressures for the Module and the operating (on or off) status of each compressor. The condenser fluid valve position is also displayed on this screen.

System status

Path: Main > Status > System

The System status screens include information about the entire System.

Temp & Humidity. View the average temperature and humidity readings at the sensors in this System (same as the Temp & Humidity scrolling status screen).

Return Sensors View the average temperature and humidity at the return sensors for this System.

Remote Sensors View the minimum temperature, average temperature, average humidity, and maximum temperature for the remote sensor probes.

Demands. View the percentage of output required of a mode to maintain its setpoint in the room.

Cool/Dehumidify View the cool mode and dehumidify mode demands (%) and the actual output. The actual reading is combined for the cool and dehumidify modes. The actual reading for the mode with the largest demand is displayed.

Humidify Demand View the actual and demanded output for the humidify mode.

Group status

Path: Main > Status > Group

The Group Status screen includes information about the member Systems of the Group and their roles.

Group Status. View the assigned role and current state of each System in the Group.

Group Run Hours. View the run hours for each System in the Group.

Reset Local System Run Hours. Reset the run hours of the local System. To reset the run hours for the other Systems, you must repeat this step at the display interface of each System. The service password is required to perform this action.

View Event Log

The event log saves status information and a message each time a change in the System is detected. Alarms and events are recorded in the log. However, status events (informational) are only displayed on the active alarms screen.

View log

Path: Main > View Log

New Events. The **New Events** option is a log of events that have occurred since the last time the log was checked.

Entire Log. The event log keeps a record of all alarms and events. Each event log entry consists of four screens of information. The initial screen consists of the following text:

- The name of the alarm
- Its index number in the log and the Module to which it applies
- The time and date the event occurred
- The name and description of the event

Use the arrow keys to scroll through the list of events.

To view more details about the event, press the ENTER key. This will allow access to three more screens (use the arrow keys to switch screens).

- Temperature and humidity
 - Supply temperature and humidity
 - Return temperature and humidity
- Pressures
 - Discharge pressure
 - Suction pressure
- Module status
 - Condenser fluid valve position
 - Output code (for use during service calls)

Clear Log. Erase all of the events in the log. When this option is selected, a confirmation screen displays and the service password must be entered to erase the log

Respond to Alarms

When an alarm is triggered, the Main Module alerts you through the display by the following methods:

- Alarm beeper
- Major or minor alarm LED
- Active alarm screen
- Alarm and event logs

Major or minor alarm LEDs

When an alarm is triggered, the Check Log LED and either the Minor Alarm LED or the Major Alarm LED activates. The Major and Minor Alarm LEDs cannot be deactivated manually; the alarm condition must be cleared to deactivate them.

Control beeper

Path: Main > Respond to Alarms

An active alarm creates a beeping sound from the display. This sound continues until you view the **Respond to Alarms** menu.

Beeper. To disable the beeper for all future alarms, set the **Beeper** setting to **Disabled**.

Beeper Volume. Set the volume of the beeper and key-click to **high**, **medium**, or **low**.

View active alarms

Path: Main > Respond to Alarms > View Active Alarms

The **Active Alarms** screen also appears on the scrolling status screens. It provides the number of the alarm (e.g., 1 of 2), a description of the condition, and a time-stamp indicating when the alarm occurred. Press the ENTER key to view details of the alarm, or press the arrow keys to view the rest of the list.



See “Entire Log” on page 51 for more information on the alarm/event details screens.

Clear active alarms

Path: Main > Respond to Alarms > Clear Active Alarms

Clears all active alarms. If the conditions that caused the alarm still exist, those conditions cause the alarm to be regenerated.

- **Clear System Alarms** – Clear active alarms that apply to the Modules in this System.
- **Clear Group Alarms** – Clear active alarms that apply to the Group.

Reset System failure

Path: Main > Respond to Alarms > Reset Sys Failure

Reset a System after a failure event has occurred. If the condition that caused the failure still exists, the System will fail again. A System will not restart after a failure until this command is executed.



Note: A System must be reset only if it is part of a Group. Stand-alone Systems will not go into the failure state.

Alarm messages and suggested actions

Displayed Alarm Message	Action Required
Air Block Interlock Open	<ul style="list-style-type: none"> • Verify that the air block panels are in place. • Confirm that the wiring connections for the air block interlock switches are secure.
Air Filter Clogged	<ul style="list-style-type: none"> • Verify the condition of the return air filters, and replace them if required. • Check the pressure drop across the filters by reviewing the System status. • Ensure that the pressure-sensing tubing is properly connected to the sensors. • Verify that the ends of the pressure-sensing tubing are not blocked or placed incorrectly. • Verify that the correct filter is selected in the System Options menu (Path: Main > Setup > System # > System Config > System Options).
Airflow Low	<ul style="list-style-type: none"> • Ensure that any field-installed dampers in the discharge duct are open. • Ensure that any field-installed dampers in the return duct are open. • Verify that the mode delay is not too short. If the mode delay is too short, the Airflow Low alarm will occur after start-up and resolve itself after a few minutes. • Check the pressure drop across the filters, and replace the filters if necessary. • Check the pressure drop across the evaporator coil on the Pressures screen of the display interface (Path: Main Menu > Status > [Module] > Pressures). The reading should be close to the recommended coil differential pressure drops indicated in the table “Coil Differential Pressure Values” on page 32. If the reading is too low based on Module size and options installed, adjust the blower speed. • Verify the proper operation of the Variable Frequency Drive (VFD) and blower motors. • Verify that the VFD overload alarm is not active.
Backup is Load Sharing	<ul style="list-style-type: none"> • A backup System is contributing to meet the room load. • No action required. The backup will return to idle when the demand falls.
Backup System Idle	<ul style="list-style-type: none"> • A primary System has come back online after a failover or load-sharing event. • No action required.
Backup System Online	<ul style="list-style-type: none"> • Indicates that a System failover has occurred. The backup System has come online because another online System either failed or was commanded off. A System Comm Loss alarm is considered to be a System failure if the Comm Loss Failover configuration setting is Yes (the default setting). • Check the event log to determine the cause of the primary System failure.
Blower 1 Requires Maintenance	<ul style="list-style-type: none"> • Verify operation of Blower 1 and perform preventive maintenance. • Reset the maintenance alarm for Blower 1 at the display interface.
Blower 2 Requires Maintenance	<ul style="list-style-type: none"> • Verify operation of Blower 2 and perform preventive maintenance. • Reset the maintenance alarm for Blower 2 at the display interface.
Compressor 1 Requires Maintenance	<ul style="list-style-type: none"> • Verify the operation of Compressor 1 and perform preventive maintenance. • Reset the maintenance alarm for Compressor 1 at the display interface.
Compressor 2 Requires Maintenance	<ul style="list-style-type: none"> • Verify the operation of Compressor 2 and perform preventive maintenance. • Reset the maintenance alarm for Compressor 2 at the display interface.

Displayed Alarm Message	Action Required
Condensate Pump Fail	<ul style="list-style-type: none"> • Verify that the condensate pump circuit breaker has not been tripped. • Ensure that the wiring between the float switch for the condensate pump and the controller is secure. • Confirm that the condensate removal lines are free of debris and are unobstructed. • Confirm the line voltage at the condensate pump. • Ensure that the condensate float switch is moving freely and does not bind. • Confirm that the condensate pump reservoir is clean and free of debris. • Replace the condensate pump.
Env Humidity High	<ul style="list-style-type: none"> • Verify that no supply air is fed directly into the return air stream. • Ensure that the alarm delay is not set too low. The delay should be long enough to allow the humidity in the room to stabilize after start-up. • Verify that the alarm threshold for the humidity of the environmental sensors (return or remote) is set 7 - 10 % above the dehumidify setpoint. • Ensure that the reheat mode is enabled and the Reheat setpoint is 2 degrees less than the cool setpoint. • Ensure that there is a proper vapor barrier within the conditioned space. • Ensure that the dehumidify mode is enabled and working properly. • Verify that the Module is configured and equipped for the dehumidify mode. • Ensure that the dehumidify mode is not disabled because of an active customer input mapped to nonessential lockout.
Env Humidity Low	<ul style="list-style-type: none"> • Ensure that the alarm delay is not set too low. The delay should be long enough to allow the humidity in the room to stabilize after start-up. • Verify that the alarm threshold for the humidity of the environmental sensors (return or remote) is set 7 - 10 % lower than the humidify setpoint. • Ensure that there is a proper vapor barrier within the conditioned space. • Verify that the Module is configured and equipped for the humidify mode. • Ensure that the humidify mode is enabled. • Check the capacity output of the humidifier, and decrease the humidifier sensitivity setpoint if required. • Ensure that the humidify mode is not disabled because of an active user-defined input mapped to nonessential lockout. • Check the alarm status and event log for humidifier alarms and perform required actions.
Env Temperature High	<ul style="list-style-type: none"> • Check whether the Module is cooling. Look for a temperature differential of 8–11 °C (15–20 °F) between the supply and return temperatures. • Ensure that there is no concentrated heat source in the return air stream of the Module. • Ensure that the alarm delay is not set too low. The delay should be long enough to allow the room temperature to stabilize after start-up. • Verify that the temperature alarm threshold for the environmental (return or remote) sensors is 7 - 10 °F above the cool setpoint. • Ensure that the cooling mode is enabled and working properly. • Ensure that the cooling mode is not disabled because of an active customer input mapped to nonessential lockout. • Check the alarm status and event log for cooling failure alarms and perform required actions.

Displayed Alarm Message	Action Required
Env Temperature Low	<ul style="list-style-type: none"> • Verify that no supply air is fed directly back into the return air. • Ensure that the alarm delay is not set too low. The delay should be long enough to allow the room temperature to stabilize after start-up. • Verify that the temperature alarm threshold for the environmental (return or remote) sensors is 7 - 10°F below the reheat setpoint. • Verify that the Module is configured and equipped for the reheat mode. • Ensure that the reheat mode is enabled and working properly. • Ensure that the reheat mode is not disabled because of an active user-defined input mapped to nonessential lockout.
Exp Module # 1 Communication Lost	<ul style="list-style-type: none"> • Verify the System CAN connections in the user interface box are connected correctly and properly terminated. • Check the CAN addresses assigned with the DIP switches on the controller board on the electrical panel. NOTE: The controller must be restarted to recognize an address change.
Exp Module # 2 Communication Lost	<ul style="list-style-type: none"> • Verify the System CAN connections in the user interface box are connected correctly and properly terminated. • Check the CAN addresses assigned with the DIP switches on the controller board on the electrical panel.
Fire Detected	<ul style="list-style-type: none"> • Follow the appropriate facility emergency protocol. NOTE: The purpose of the fire sensor is to warn you of possible equipment damage. It is NOT intended to provide a fire alarm system to protect the facility and the lives of its occupants. • Confirm that the wiring connections are secured to the wiring harness. • Verify the fire detector (firestat) is set to 125° F. • Reset the firestat by pressing the reset button on the firestat. • Replace the fire detector (firestat).
Fluid Coil No Coolant Flow	<ul style="list-style-type: none"> • Verify chilled water supply. • Check the operation of the flow switch. • Check the electrical connection to the flow switch. • Verify that the Economizer automatic coolant isolation valve is open (if equipped). • Verify that the valve type setting is correct in the System Configuration (Path: Main > Setup > System # > System Config > Valve Types).
Fluid Coil Actuator Fail	<ul style="list-style-type: none"> • Verify the proper connections between the actuator and the controller board. • Confirm that the control voltage and signal voltage reach the actuator. • Ensure that the proper Module Configuration is defined for this Module, especially that the coil Configuration and the MultiCool/Economizer actuator type are correct. • Replace the fluid coil actuator.
Fluid Coil Coolant Temp High	<ul style="list-style-type: none"> • For Economizer Modules, check the operation of the outdoor heat exchanger. • For MultiCool Modules, check the chilled water supply temperature. • Verify that the fluid coil coolant temperature high threshold is not set below the normal temperature of your chilled water supply.
Fluid Coil Coolant Temp Low	<ul style="list-style-type: none"> • For Economizer Modules, check the operation of the outdoor heat exchanger. • For MultiCool Modules, check the chilled water supply temperature. • Verify that the low threshold for the fluid coil coolant temperature is not set above the normal temperature of your chilled water supply.

Displayed Alarm Message	Action Required
Group Configuration Invalid	<ul style="list-style-type: none"> • Check that the # Systems setting (Path: Main > Setup > Group > Group Config) agrees with the actual number of Systems connected to the Group. Adjust this setting to match the number of connected Systems.
Group Configuration Conflict	<ul style="list-style-type: none"> • Verify the Group configuration settings (Path: Main > Setup > Group) are correct. The Group detected that one or more Systems in the Group have different Group configuration settings and changed the settings of that System.
Group Fatal Fire Shutdown	<ul style="list-style-type: none"> • Check the Systems in this Group for fire alarms. The Group Fatal Fire Shutdown occurs only when the Group Fire Alarm configuration setting (Path: Main > Setup > Group Config > Grp Fire Alarm) is On. While the fire alarm is active, the Group will remain shut down.
Group Fatal Smoke Shutdown	<ul style="list-style-type: none"> • Check the Systems in this Group for smoke alarms. The Group Fatal Smoke Shutdown occurs only when the Group Smoke Alarm configuration setting (Path: Main > Setup > Group Config > Grp Smoke Alarm) is On. While the smoke alarm is active, the Group will remain shut down.
Head Pressure High	<ul style="list-style-type: none"> • Confirm that the air-cooled condenser is operating properly and that the setpoints are correct. • For water/glycol configuration, confirm that the condenser loop pumps are operating properly. • Ensure that the air-cooled condenser is free from debris on the air intake side. • Verify that all isolation valves to the condenser loop or interconnecting piping are open. • For water/glycol cooled configuration, confirm that all air has been purged from the condenser loop. • For water/glycol cooled configuration, confirm that the glycol-to-water concentration is 40% glycol to 60% water. • Verify (water/glycol) cooled configuration, confirm the indoor Module and outside heat exchanger that interconnects between the wiring. • Verify (water/glycol) correct operation of the condenser fluid valve actuator. • Confirm proper refrigerant charge in the Module. • Ensure that the Module is set to the proper heat of rejection method on the display interface (Path: Main Menu > Setup > System # > System Config > System Options). • Verify (water/glycol) cooled configuration, that the strainers are clear and open. • Confirm the proper operation and trip point of the high head pressure switch. • Evaluate field piping for proper line sizes and proper installation. • Verify that the Economizer isolator valve is open (if installed).
Heater Requires Maintenance	<ul style="list-style-type: none"> • Verify the operation of the heater and perform preventive maintenance. • Reset the maintenance alarm for the heater at the display interface.
Humidifier Current High	<ul style="list-style-type: none"> • Verify that the proper voltage is being applied to the humidifier cylinder. • Confirm that there are secure and proper line voltage connections to the humidifier cylinder. • Ensure that the humidifier water supply has not been conditioned. Conditioning can increase the water conductivity. • Check the electrodes in the humidifier cylinder for mineral buildup that bridges the electrodes. • Check the fill valve for debris which may prevent the valve from closing.

Displayed Alarm Message	Action Required
Humidifier Cylinder Depleted	<ul style="list-style-type: none"> • Replace the disposable cylinder. • Clean the reusable humidifier cylinder (optional).
Humidifier Cylinder Full When Off	<ul style="list-style-type: none"> • Check the humidifier fill and drain valves for clogging. • Check the operation of the humidifier drain solenoid.
Humidifier Drain Malfunction	<ul style="list-style-type: none"> • Ensure that the drain is free of any debris. • Verify the operation of the drain solenoid valve.
Humidifier Excessive Foam	<ul style="list-style-type: none"> • Verify that the humidifier water supply is not using conditioned water and that the water does not contain contaminants. • Check the humidifier water supply hose for dirt and contaminants. • Drain the humidifier canister and refill with fresh water.
Humidifier Excessive Output Reduction	<ul style="list-style-type: none"> • Reduce the humidifier sensitivity setting on the display interface (Path: Main > Setup > System # > System Config > Humid. Sensitivity) if necessary.
Humidifier Fail	<ul style="list-style-type: none"> • Check the event log for other humidifier alarms.
Humidifier Fault Tolerance Exceeded	<ul style="list-style-type: none"> • Humidifier has experienced three faults within 30 minutes. • Reset the humidifier from the display interface (Path: Main > Setup > Module > [Module Alarm Occurred in] > Module Control > Reset Humidifier). • Check the alarm status and event log for humidifier alarms and perform required actions.
Humidifier Internal Memory Error	<ul style="list-style-type: none"> • Check the controller connections to the humidifier for electrical discharge.
Humidifier No Power	<ul style="list-style-type: none"> • Verify that the humidifier circuit breaker has not been tripped. • Confirm that the line voltage connections to the cylinder are secure and correct.
Humidifier Requires Maintenance	<ul style="list-style-type: none"> • Verify the operation of the humidifier and perform preventive maintenance. • Reset the maintenance alarm for the humidifier at the display interface.
Humidifier Water Conductivity High	<ul style="list-style-type: none"> • Verify that the proper voltage is being applied to the humidifier cylinder. • Confirm that the line voltage connections to the cylinder are secure and correct. • Ensure that the water supply to the humidifier has not been conditioned. Conditioned water can increase water conductivity.
Humidifier Water Level Low	<ul style="list-style-type: none"> • Verify that the humidifier water supply is open and flowing to the humidifier water connection. • Confirm that the inlet water strainer on the humidifier fill solenoid is clear and free of debris. • Ensure that the water pressure is at least 206 kPa (30 psig). • Verify the operation of the fill solenoid valve. • Check the drain valve for debris which may prevent the valve from closing. • Check the steam supply hose for kinks or sags that may cause back pressure.
Module # Failed	<ul style="list-style-type: none"> • Check the event log for other alarms for this Module.
Module Powered Up	<ul style="list-style-type: none"> • The Module has successfully started.

Displayed Alarm Message	Action Required
MultiCool Coil No Coolant Flow	<ul style="list-style-type: none"> • Verify the flow from the chilled water supply. • Check the operation of the flow switch. • Check the electrical connections to the flow switch. • Verify that the chilled water supply isolation valve is open.
No Backup Systems Available	<ul style="list-style-type: none"> • Check the number of Systems designated for the backup role. • Check that the primary or backup Systems are not in a failed state, in the Comm Lost state, or Off.
Primary Sensors Failed	<ul style="list-style-type: none"> • Verify that there is a proper CAN connection between the sensors and the user interface box. • Check the connections of the 25-pin serial communication cable from the main controller board to the customer interface box. • Replace the sensor assembly.
Remote Sensor Removed	<ul style="list-style-type: none"> • Check the CAN bus connection to the remote sensor. • Disregard this alarm if you removed the remote sensor.
Remote Sensor Added	<ul style="list-style-type: none"> • Check the CAN bus connection to the remote sensor. • Disregard this alarm if you added the remote sensor.
Replace Steam Cylinder	<ul style="list-style-type: none"> • Replace the steam cylinder.
Return Sensor Fail	<ul style="list-style-type: none"> • Verify that there is a proper CAN connection between the sensors and the user interface box. • Replace the sensor assembly.
Secondary Sensors Failed	<ul style="list-style-type: none"> • Verify that there is a proper CAN connection between the remote sensors and the user interface box. • Check the remote sensor dip switch settings for proper address configuration. • Check the connections of the 25 pin serial communication cable from the main controller board to the customer interface box. • Replace the sensor assembly.
Smoke Detected	<ul style="list-style-type: none"> • Confirm that the wiring connections to the wiring harness are secure. • Ensure the smoke head and sub-base are properly attached. • Ensure that there is not dirt or dust on the smoke head. Use pressurized air to clean the smoke head chamber. • Replace the smoke detector.
Suction Pressure Low	<ul style="list-style-type: none"> • Confirm (at the display interface) that the pressure drop across the evaporator coil is within the acceptable range (Path: Main Menu > Status > [Main or Expansion] Module > Pressures). • Confirm that the cooling setpoint is not below 20°C (68°F). • Verify the condition of the return filters. Check (at the display interface) the pressure drop across the filters (Path: Main Menu > Setup > System > System Config > System Options). • Confirm that the outdoor heat exchanger is operating properly and that its setpoints are correct. • Confirm proper refrigerant charge in the Module. • Confirm proper Module setup and that the correct Module size is indicated on the display interface. • Verify that the evaporator coil is clean and free of debris.

Displayed Alarm Message	Action Required
Supply Humidity High	<ul style="list-style-type: none"> • Verify that the suction pressure is not below 58 psig (400 kPa). • Ensure that the alarm delay is not set too low. The delay should be long enough to allow the Module to control the humidity after start-up. • Ensure the alarm threshold for the humidity of the supply air is set above the humidify and dehumidify setpoints. • Verify that there is proper airflow through the Module. (Check the pressure drop across the evaporator coil.) • Check the capacity output of the humidifier and reduce it if required. • Ensure that there is a proper vapor barrier within the conditioned space. • Verify that the Module is configured and equipped for the dehumidify mode. • Ensure the dehumidify mode is enabled. • Ensure the dehumidify mode is not disabled because of an active customer input mapped to a nonessential lockout.
Supply Humidity Low	<ul style="list-style-type: none"> • Ensure the alarm delay is not set too low. The delay should be long enough to allow the Module to control the humidity after start-up. • Ensure the alarm threshold for the humidity of the supply air is set below the humidify and dehumidify setpoints. • Check the capacity output of the humidifier and increase it if required. • Ensure there is a proper vapor barrier within the conditioned space. • Verify the Module is configured and equipped for the humidify mode. • Ensure the humidify mode is enabled. • Ensure the humidify mode is not disabled because of an active customer input mapped to a nonessential lockout.
Supply Sensor Fail	<ul style="list-style-type: none"> • Verify that there is a proper CAN connection between the sensors and the user interface box. • Check the connections of the 25 pin serial communication cable from the main controller board to the customer interface box. • Replace the sensor assembly.
Supply Temperature High	<ul style="list-style-type: none"> • Ensure that the alarm delay is not set too low. The delay should be long enough to allow the Module to control the temperature after start-up. • Verify that the supply air temperature alarm threshold is set above the cool and reheat setpoints. • Verify that there is proper airflow through the Module (check the pressure drop across the evaporator coil). • Ensure that the cool mode is enabled. • Ensure that the cool mode is not disabled because of an active customer input mapped to nonessential lockout.
Supply Temperature Low	<ul style="list-style-type: none"> • Ensure that the alarm delay is not set too low. The delay should be long enough to allow the Module to control the temperature after start-up. • Verify that the Module is configured and equipped for the reheat mode. • Ensure that the supply air temperature alarm threshold is set below the reheat and cool setpoints. • Ensure that the reheat mode is enabled. • Ensure that the reheat mode is not disabled because of an active customer input mapped to nonessential lockout. • Verify that there is proper airflow through the Module (check the pressure drop across the evaporator coil).

Displayed Alarm Message	Action Required
System Comm Lost	<ul style="list-style-type: none"> • Check that the System is receiving power. • Check the external CAN bus connections. • Check the System ID DIP switch settings of every Main Module in the Group. Each Main Module must have a unique address. See the <i>Installation Manual</i> for the correct DIP switch settings.
System Failure	<ul style="list-style-type: none"> • After correcting the cause of the system failure, perform a Reset System Failure command (Path: Main > Respond to Alarms > Reset Sys Failure).
System Fire Detected	<ul style="list-style-type: none"> • Follow the appropriate facility emergency protocol. NOTE: The purpose of the fire sensor is to warn you of possible equipment damage. It is NOT intended to provide a fire alarm system to protect the facility and the lives of its occupants. • See “Fire Detected” on page 55 for the appropriate alarm actions.
System Off	<ul style="list-style-type: none"> • Turn on power to the System (Path: Main > On/Off).
System Smoke Detected	<ul style="list-style-type: none"> • Check the Modules in the System for Smoke Detected alarms. • Follow the appropriate facility emergency protocol. NOTE: The purpose of the smoke sensor is to warn you of possible equipment damage. It is NOT intended to provide a smoke alarm system to protect the facility and the lives of its occupants. • See “Smoke Detected” on page 58 for the appropriate alarm actions.
VFD # 1 Requires Maintenance	<ul style="list-style-type: none"> • Verify the operation of VFD # 1 and perform preventive maintenance. • Reset the maintenance alarm for VFD #1 on the display interface.
VFD # 2 Requires Maintenance	<ul style="list-style-type: none"> • Verify the operation of VFD # 2 and perform preventive maintenance. • Reset the maintenance alarm for VFD #2 on the display interface.
VFD #1 Fail	<ul style="list-style-type: none"> • Check the event log for other VFD alarms to determine the cause of the failure.
VFD #2 Fail	<ul style="list-style-type: none"> • Check the event log for other VFD alarms to determine the cause of the failure.
Water Detected	<ul style="list-style-type: none"> • Determine the source of the leak, and repair it. • Confirm that the water detector is not short-circuited to metal and ensure that there is not debris or soldering on the rope component of the water detector that could be providing false detection. • Ensure that the water detector is properly mounted and secured to the bottom of the Module or the floor. • Confirm that the wiring connections are secure. • Replace the water detector.

Network Management Card

Quick Configuration

The NetworkAIR FM DX is shipped with a Network Management Card that enables you to manage the air conditioner over your network. You must set up the Network Management Card to control the NetworkAIR FM DX through a network.

Overview

You must configure the following TCP/IP settings before the NetworkAIR FM DX can operate on a network:

- IP address of the Network Management Card
- Subnet mask
- Default gateway



Note: Never use the loopback address (127.0.0.1) as the default gateway address for the Network Management Card. Doing so will disable the card and will require you to reset TCP/IP settings to their defaults using a local serial login.

If a default gateway is unavailable, use the IP address of a computer that is located on the same subnet as the Network Management Card and that is usually running. The Network Management Card uses the default gateway to test the network when traffic is very light.



See “Watchdog Features” in the “Introduction” of the *NetworkAIR FM User’s Guide* for more information about the watchdog role of the default gateway. You can find the *NetworkAIR FM User’s Guide* on the Utility CD that came with your equipment or online at www.apc.com.

TCP/IP configuration methods

Use one of the following methods to define the TCP/IP settings needed by the Network Management Card:

- APC Device IP Configuration Wizard (See “APC Device IP Configuration Wizard” on page 62.)
- BOOTP or DHCP server (See “BOOTP and DHCP configuration” on page 62.)
- Networked computer (See “Remote access to the control console” on page 64.)

APC Device IP Configuration Wizard

You can use the APC Device IP Configuration Wizard at a computer running Microsoft Windows 2000, Windows 2003, or Windows XP to configure a Network Management Card.

1. Insert the Utility CD into a computer on your network and click the "Device IP Configuration Wizard" link.
2. Launch the Device IP Configuration Wizard, when prompted, or, if prompted to restart the computer, access the Wizard from the **Start** menu after the computer has restarted.
3. Wait for the Wizard to detect the unconfigured Network Management Card, then follow the on-screen instructions.



Note: If you leave the **Start a Web browser when finished** option enabled, you can use **apc** for both the user name and password to access the Network Management Card through your browser.

BOOTP and DHCP configuration

TCP/IP Configuration, which you access by selecting the **Administration** tab, the **Network** option on the top menu bar, and **TCP/IP** on the left navigation menu, identifies how the TCP/IP settings will be defined. The possible settings are **Manual**, **DHCP**, **BOOTP**, and **DHCP & BOOTP** (the default setting).



Note: The **DHCP & BOOTP** setting assumes that a properly configured DHCP or BOOTP server is available to provide TCP/IP settings to the Network Management Card.

With **Boot Mode** set to DHCP & BOOTP (the default setting), the Network Management Card attempts to discover a properly configured server. It first searches for a BOOTP server, then a DHCP server, and repeats this pattern until it discovers a BOOTP or DHCP server.



See "BOOTP" on this page or "DHCP" on page 63 for configuration information.

BOOTP. You can use an RFC951-compliant BOOTP server to configure the TCP/IP settings for the Network Management Card.

1. Enter the Network Management Card MAC and IP addresses, the subnet mask and default gateway settings, and an optional bootup file name in the BOOTPTAB file of the BOOTP server.



Note: For the MAC address, look on the nameplate of the equipment. The MAC address is also available on the display interface.

Path: **Setup>System>Network Config.**

2. When the Network Management Card reboots, the BOOTP server provides it with the TCP/IP settings.
 - If you specified a bootup file name, the Network Management Card attempts to transfer that file from the BOOTP server using TFTP or FTP. The Network Management Card assumes all settings specified in the bootup file.
 - If you did not specify a bootup file name, the Network Management Card can be configured remotely by using the control console or the Web interface (user name and password are both **apc**, by default).



To create the bootup file, see your BOOTP server documentation.

DHCP. You can use an RFC2131/RFC2132-compliant DHCP server to configure the TCP/IP settings for the Network Management Card.



This section briefly summarizes the Network Management Card communication with a DHCP server. For more detail about how a DHCP server is used to configure the network settings for a Network Management Card, see “DHCP Configuration” in the *NetworkAIR FM DX User’s Guide*.

1. A Network Management Card sends out a DHCP request that uses the following to identify itself:
 - A Vendor Class Identifier (APC by default)
 - A Client Identifier (by default, the MAC address value of the Network Management Card)
 - A User Class Identifier (by default, the identification of the application firmware of the Network Management Card)
2. A properly configured DHCP server responds with a DHCP offer that includes all of the settings that the Network Management Card needs for network communication. The DHCP offer also includes the Vendor Specific Information option (DHCP option 43). By default, the Network Management Card will ignore DHCP offers that do not encapsulate the APC cookie in the Vendor Specific Information option using the following hexadecimal format:

Option 43 = 01 04 31 41 50 43

where

- the first byte (01) is the code
- the second byte (04) is the length
- the remaining bytes (31 41 50 43) are the APC cookie



See your DHCP server documentation to add code to the Vendor Specific Information option.

To change the control console **DHCP Cookie Is** setting, use the **Advanced** option in the TCP/IP menu. See “Remote access to the control console” on page 64.

To change the Web interface setting **Require vendor specific cookie to accept DHCP Address**, which is enabled by default, first choose **DHCP** under the **TCP/IP Configuration** heading by selecting the **Administration** tab, the **Network** option on the top menu bar, and **TCP/IP** on the left navigation menu. To disable the APC cookie requirement, click **Next** to access the **DHCP Configuration** page, and unmark the checkbox "Require vendor specific cookie to accept DHCP Address."

Remote access to the control console

From any computer on the same subnet as the Network Management Card, you can use ARP and Ping to assign an IP address to a Network Management Card, and then use Telnet to access the control console of that Network Management Card and configure the needed TCP/IP settings.



Note: After a Network Management Card has its IP address configured, you can use Telnet, without first using ARP and Ping, to access that Network Management Card.

1. Use ARP to define an IP address for the Network Management Card, and use the MAC address of the Network Management Card in the ARP command. For example, to define an IP address of 156.205.14.141 for a Network Management Card that has a MAC address of 00 c0 b7 63 9f 67, use one of the following commands:

– Windows command format:

```
arp -s 156.205.14.141 00-c0-b7-63-9f-67
```

– LINUX command format:

```
arp -s 156.205.14.141 00:c0:b7:63:9f:67
```



Note: For the MAC address, look on the nameplate of the Network Management Card. The MAC address is also available on the display interface.

Path: Setup>System>Network Config.

2. Use Ping with a size of 113 bytes to assign the IP address defined by the ARP command. For the IP address defined in step 1, use one of the following Ping commands:

– Windows command format:

```
ping 156.205.14.141 -l 113
```

– LINUX command format:

```
ping 156.205.14.141 -s 113
```

3. Use Telnet to access the Network Management Card at its newly assigned IP address. For example:

```
telnet 156.205.14.141
```

4. Use **apc** for both user name and password.



See “Control console” on page 65 to finish the configuration.

Control console

After you log on at the control console, as described in “Remote access to the control console” on page 64:

1. Choose **Network** from the **Control Console** menu.
2. Choose **TCP/IP** from the **Network** menu.
3. If you are not using a BOOTP or DHCP server to configure the TCP/IP settings, select the **Boot Mode** menu. Select **Manual boot mode**, and then press ESC to return to the **TCP/IP** menu. (Changes will take effect when you log out.)
4. Set the **System IP**, **Subnet Mask**, and **Default Gateway** address values.
5. Press CTRL+C to exit to the **Control Console** menu.
6. Log out (option 4 in the **Control Console** menu)

Access a Configured Unit

Overview

After the NetworkAIR FM DX is running on your network, you can use the interfaces summarized here to access the NetworkAIR FM DX.



See the *User's Guide* for more information on the interfaces.

Web interface

As your browser, you can use Microsoft® Internet Explorer 5.5 and higher (on Windows operating systems only), Firefox 1.x by Mozilla (on all operating systems), or Netscape® 7.x and higher (on all operating systems) to access the Management Card through its Web interface. Other commonly available browsers also may work but have not been fully tested by APC. To use the Web browser to configure NetworkAIR FM options or to view the event log, you can use either of the following:

- The HTTP protocol (enabled by default) provides authentication by user name and password but no encryption.
- The more secure HTTPS protocol provides extra security through Secure Sockets Layer (SSL) and encrypts user names, passwords, and data being transmitted. It also provides authentication of Network Management Cards by means of digital certificates.

To access the Web interface and configure the security of your device on the network:

1. Address the Network Management Card by its IP address (or DNS name, if configured).
2. Enter the user name and password (by default, **apc** and **apc** for an Administrator, or **device** and **apc** for a Device Manager).
3. Select and configure the type of security you want. (This option is available only for Administrators.) On the **Administration** tab, select **Network** on the top menu bar and the **access** option under the **Web** heading on the left navigation menu to enable or disable the HTTP or HTTPS protocols.



See “Security” in the *Security Handbook* available on the Utility CD or on the APC Web site, www.apc.com, for information on choosing and setting up your network security.

Telnet/SSH

You can access the control console through Telnet or Secure SHell (SSH), depending on which is enabled. (An Administrator can enable these access methods in the Web interface by selecting the **Administration** tab, then **Network** on the top menu bar, and the **access** option under the **Console** heading on the left navigation menu.) By default, Telnet is enabled. Enabling SSH automatically disables Telnet.

Telnet for basic access. Telnet provides the basic security of authentication by user name and password, but not the high-security benefits of encryption. To use Telnet to access the Network Management Card control console from any computer on the same network:

1. At a command prompt, use the following command line, and press ENTER:

```
telnet address
```

As *address*, use the Network Management Card IP address (or DNS name, if configured).

2. Enter the user name and password (by default, **apc** and **apc** for an Administrator, or **device** and **apc** for a Device User).

SSH for high-security access. If you use the high security of SSL for the Web interface, use Secure SHell (SSH) for access to the control console. SSH encrypts user names, passwords, and transmitted data.

The interface, user accounts, and user access rights are the same whether you access the control console through SSH or Telnet, but to use SSH, you must first configure SSH and have a SSH client program installed on your computer.



See the *User's Guide* for more information on configuring and using SSH.



Note: The menu structure for administration and device management in the control console differs from the menu structure for these areas in the Web interface. See the *User's Guide* for an overview of the control console menus

SNMP

After you add the PowerNet[®] MIB to a standard SNMP MIB browser, you can use that browser for SNMP access to the NetworkAIR FM DX. The default read community name is **public**; the default read/write community name is **private**.



Note: If you enable SSL and SSH for their high-security authentication and encryption, disable SNMP. Allowing SNMP access to the NetworkAIR FM DX compromises the high security you implement by choosing SSL and SSH. To disable SNMP, you must be an Administrator; use the **SNMP** option of the **Network** menu.

FTP/SCP

You can use FTP (enabled by default) or Secure CoPy (SCP) to transfer new firmware to the Network Management Card, or to access a copy of the event logs of the NetworkAIR FM. SCP provides the higher security of encrypted data transmission and is enabled automatically when you enable SSH.



Note: If you enable SSL and SSH for their high-security authentication and encryption, disable FTP. Allowing file transfer to the NetworkAIR FM through FTP compromises the high security you implement by choosing SSL and SSH. To disable FTP, you must be an Administrator; use the **FTP Server** option of the **Network** menu.

To access the Network Management Card through FTP or SCP, the default user name and password are **apc** and **apc** for an Administrator, or **device** and **apc** for a Device Manager. In the command line, use the IP address of the unit.



See: the *User's Guide* to use FTP or SCP to transfer firmware files to or to retrieve the log file from the Network Management Card.

Recover From a Lost Password

To access the control console, you can use a local computer (a computer that connects to the Network Management Card or other device through the serial port).

1. Select a serial port at the local computer, and disable any service that uses that port.
2. Use the configuration cable to connect the selected port to the serial port (J2) on the controller board. The controller board is in the right compartment of the electrical panel.



Electrical Hazard: Potentially dangerous and lethal voltages exist within the electrical cabinet. Do not touch components on the electrical panel other than the serial port.

3. Run a terminal program (such as HyperTerminal[®]) and configure the selected port as follows:
 - 2400 bps
 - 8 data bits
 - no parity
 - 1 stop bit
 - no flow control
4. Press **ENTER**, repeatedly if necessary, to display the **User Name** prompt. If you are unable to display the **User Name** prompt, verify the following:
 - The serial port is not in use by another application.
 - The terminal settings are correct as specified in step 3.
 - The correct cable is being used as specified in step 2.
5. Press the **Reset** button on the faceplate of the Network Management Card. The Status LED will flash alternately orange and green. Press the **Reset** button a second time immediately while the LED is flashing to reset the user name and password to their defaults temporarily.
6. Press **ENTER** as many times as necessary to re-display the **User Name** prompt, then use the default, **apc**, for the user name and password. (If you take longer than 30 seconds to log on after the **User Name** prompt is re-displayed, you must repeat step 5 and log on again.)
7. From the **Control Console** menu, select **System**, then **User Manager**.
8. Select **Administrator**, and change the **User Name** and **Password** settings, both of which are now defined as **apc**.
9. Press **CTRL+C**, log off, reconnect any serial cable you disconnected, restart any service you disabled, close all panels, and re-install doors.



Electrical Hazard: Potentially dangerous and lethal voltages exist within the electrical cabinet. Do not touch components on the electrical panel, other than the serial port.

Maintenance

Monthly Preventive Maintenance

The following pages can be photocopied and used during the maintenance procedures. After they have been filled out, save for future reference.

Prepared by: _____

Model Number: _____

Serial Number: _____

Date: _____

Environment

- In what type of room is the Module located?

- Is the Module maintaining the temperature and humidity setpoints?

- Temperature setpoint _____
- Humidity setpoint _____

- Is there visible damage to the Module (dents, scratches)?

- Check for environmental damage (dirt, dust, debris, liquid stains) around the Module installation area.

- Record the room temperature and humidity near the return air supply of the Module.

- Temperature _____
- Humidity _____

- Record the alarm history for the previous month.

Cleanliness

- Check the condenser coil or fluid cooler coil for cleanliness. Clean if necessary.

- Check the condition of the return air filters. Change if necessary.

- Check the condition of the drain pan and the accumulation of debris in the pan. Clean as required.

Mechanical

- Check the evaporator fans and motors. All components should be moving freely with no signs of binding or damage.
- Check the condenser fluid cooler motors, fan blades, and fan guards. All components should be moving freely with no signs of binding or damage.
- Inspect the set-screws on fan blades to make sure that they are tight.
- Verify that the condensate line is unrestricted.
- Verify there are no leaks at the fill and drain valves of the humidification system.
- Verify the humidification modes of operation are functional.
- Ensure that there are no kinks in the steam delivery system from the cylinder top to the steam distributor.
- On optional cleanable cylinders, check for build-up in the cylinder and clean as required.
 - Cylinder size _____
- Replace disposable humidifier cylinders as required.
 - Cylinder size _____
- Visually inspect the liquid line sight glass for excessive bubbles (when full cool) and condition of moisture indicator.
- Verify the chilled water supply temperature for Modules with the MultiCool option.
 - Chilled water supply temperature.

Electrical

- Inspect the electrical panel for tight connections. Look for any overheated connections from loose contact terminals.
- Confirm that the incoming main power matches the Module nameplate. Measurement should be within 10% of nameplate listing.
- Verify the control transformer voltages. Voltage should be within 10% of the rated output voltage.

Quarterly Preventive Maintenance

* Perform all the Monthly Preventive Maintenance items **and** the items below.

Prepared by: _____

Model Number: _____

Serial Number: _____

Date: _____

Mechanical

- Check the refrigeration lines for leaks.
- Verify that the blower/motor evaporator hardware is tight.

Electrical

- Record the amperages for the following components.

Component	L1	L2	L3	FLA
Evaporator fan motors				
Motor #1				
Motor #2				
Condenser fan motors				
Motor #1				
Motor #2				
Motor #3				
Motor #4				
Compressors				
Compressor A				
Compressor B				
Reheat				
Humidifier				
Glycol pumps				
Pump #1				
Pump #2				

Functional tests

- ❑ Verify the following modes of operation:
 - Full cooling
 - Full reheat
 - Humidification
 - Dehumidification
 - MultiCool
 - Economizer

- ❑ Verify the operation of these actuators:
 - MultiCool or Economizer
 - Head pressure control valve (water/glycol modules)

Semi-Annual Preventive Maintenance

* Perform all the Monthly/Quarterly Preventive Maintenance items **and** the items below.

Prepared by: _____

Model Number: _____

Serial Number: _____

Date: _____

Cleanliness

- Check the cleanliness of the evaporator coil. Clean if required.

Mechanical

- Check the glycol concentrate of the glycol loop (glycol modules only).
 - Glycol % _____
 - Water % _____

Electrical

- Verify contactor and relay operation integrity.
- Check the main power wiring for the following components:
 - Reheat elements
 - Evaporator and condenser motors
 - Compressors
 - Humidifiers
 - Glycol pumps

Functional tests

- Measure the refrigerant pressures.

	Head Pressure		Suction Pressure	
Compressor on				
Compressors on				

- Check the operation of the thermal expansion valve. Verify superheat and sub-cooling of the System in full cool mode:
 - Superheat _____
 - Sub-cooling _____
- Check the operation of the head pressure switch:
 - Cut-out PSI (kPa)_____
- Verify the operation of the water/glycol regulating valves.
- Check the operation of the smoke, fire, and water detected alarms (if applicable).
- Confirm the operation of the fluid cooler or air cooled condenser and the flooded head pressure controls, if used.
- Confirm the operation of the Redundant Group and change over capabilities.

Troubleshooting

Problem	Possible Cause	Corrective Action
Airflow too low	<ul style="list-style-type: none"> • Blower setting too low • Dirty or blocked air filters • External static pressure too high • Raised floor height too low • Return airflow restriction • Supply airflow restriction 	<ul style="list-style-type: none"> • Increase blower setting. • Check filters and replace as needed. • Increase the blower speed to compensate. • Verify floor height is not less than 18 in. Check for under floor obstructions. • Check return duct sizing and return grille openings. • Check supply duct sizing and supply grille openings.
Blower motor fails to start	<ul style="list-style-type: none"> • System is off • System time delay is active • Remote shutdown or input contact is active • Airblock interlock alarm • VFD alarm • Frequency drive has failed • Blown fuse or fuses • No run signal to VFD • Blower failure 	<ul style="list-style-type: none"> • Turn System on. • Allow ample time to expire. • Check input contact configuration settings. • Check airblock panels and secure as needed. Check interlock switches and wiring connections. • Check alarm for specific fault code. • Replace the frequency drive. • Check for shorted wiring, failed motor, failed VFD, and proper voltage. Replace fuses with specified type. • Check VFD control wiring and connections. • Replace blower assembly.

Problem	Possible Cause	Corrective Action
Compressor fails to start	<ul style="list-style-type: none"> • Cooling mode disabled • Cooling setpoint too high • Compressor circuit breaker is tripped • System is in alarm • Head pressure alarm, high pressure switch is open • Low suction pressure • Compressor thermal overload is open • Compressor failure 	<ul style="list-style-type: none"> • Enable cooling mode. • Adjust the cooling setpoint below the return air temperature by at least 4°F (2°C) to activate the compressor or compressors. • Check the compressor windings and verify open or short to ground windings. Reset the circuit breaker and check the compressor contactor load side for proper voltage to the compressor. • Check front panel display for active system alarms. • For air cooled systems, check the condenser coil for air-obstructions, fan operation, and settings. Manually reset the high pressure switch. • For water cooled systems, check the condenser water flow rate and water supply temperature. Check the pressure drop across the heat exchanger. Check and clean field installed strainers. Check the water regulating valve, actuator, and linkage for proper operation. • For glycol cooled systems, check the fluid cooler coil for air obstructions and proper fan operation. Check the water flow rate and water supply temperature. Check the pressure drop across the heat exchanger. Check and clean field installed strainers. Check water regulating valve, actuator, and linkage for proper operation. • Check for a restriction in the filter drier. • Check for power at the liquid line solenoid coils. Check solenoid coil and valve operation. • Check for proper TXV operation and superheat. • Check refrigerant charge, check system for leaks. • Verify the return air temperature is not below 68°F. • Check for low head pressure. • Check compressor shell temperature. Check compressor for open windings and allow sufficient time for the compressor to cool down to room temperature. After the thermal overload resets, determine the cause of the failure. • Determine the cause of failure and replace the compressor set.

Problem	Possible Cause	Corrective Action
Compressor noisy	<ul style="list-style-type: none"> • Compressor or compressors may be rotating in the wrong direction • Liquid slugging • High head pressure 	<ul style="list-style-type: none"> • Verify the pressure differential across the suction and discharge for each compressor. If no differential is present, verify the correct phasing to each compressor. • Check for low evaporator superheat. • Check operation of crankcase heaters. • Verify liquid line solenoid valves close tightly during the off cycle. Check for obstructions which may prevent the valve from closing. • Check operating head pressure.
Controls erratic or inoperative	<ul style="list-style-type: none"> • Control transformer problem • Loose or broken wiring • Module configured incorrectly • System is in alarm 	<ul style="list-style-type: none"> • Check control transformers for proper input voltage. • Check control transformer secondary voltage. Output should be within + or - 10% of rated output. • Check wiring for loose or broken connections. • Set module configuration according to nameplate and options selected. • Check front panel display for active system alarm.
Evaporator coil ices	<ul style="list-style-type: none"> • Dirty or blocked evaporator coil • Dirty or blocked air filters • Low airflow • Low evaporator superheat • Low return air temperature • Low refrigerant charge 	<ul style="list-style-type: none"> • Clean evaporator coil. • Check filters and replace as needed. • Check for correct airflow setting. • Check superheat and adjust to 10-15°F. • Verify the return air temperature is not below 20°C (68°F). • Check for short cycling of cold supply air. • Check subcooling and ensure it is at least 10-15°F. Repair leak and recharge system.
Head pressure too high	<ul style="list-style-type: none"> • Air cooled condenser malfunction • Condenser water regulating valve malfunction • Overcharge of refrigerant • Non-condensable in system • Fluid cooler malfunction • Fluid pump malfunction • Low fluid flow • Glycol concentration higher than 40% 	<ul style="list-style-type: none"> • Check and clean the condenser coil. Check condenser fan operation and settings. • Check water regulating valve, actuator, and linkage for proper operation. • Remove excess refrigerant from system. • Recover refrigerant charge, evacuate system and recharge. • Check and clean the fluid cooler coil. Check fluid cooler fan operation. • Check pump operation. • For water cooled systems, check the condenser water flow rate and water supply temperature. Check pressure drop across the heat exchanger. Check and clean field installed strainers. • For glycol cooled systems, check the water flow rate and water supply temperature. Check pressure drop across the heat exchanger. Check and clean field installed strainers. • Verify glycol concentration, reduce to maximum 40%.

Problem	Possible Cause	Corrective Action
Head pressure too low	<ul style="list-style-type: none"> • Low refrigerant charge • Condenser fan settings too low • Condenser water regulating valve malfunction • System requires flooded condenser control during low ambient conditions 	<ul style="list-style-type: none"> • Check subcooling and ensure it is at least 10-15°F. Repair leak and recharge system. • Adjust condenser fan setpoints. • Check water regulating valve, actuator, and linkage for proper operation. • Install flooded condenser controls.
Humidifier inoperative	<ul style="list-style-type: none"> • Humidification mode disabled • Humidification setpoint too low • Humidifier is in alarm • Humidifier canister full of sediment • Blown fuse or fuses • No power to electrodes 	<ul style="list-style-type: none"> • Enable humidification mode. • Raise humidification setpoint. • Check front panel display for active humidifier alarms. • Replace humidifier canister. • Check for shorted wiring, excessive current draw, and proper input voltage. Replace fuse or fuses with the specified type. • Check contactor, wiring, and connections.
Humidity control is not tight enough	<ul style="list-style-type: none"> • Excessive outside air infiltration • Lack of proper room vapor barrier • Humidification/dehumidification setpoints not close enough • Humidifier sensitivity % setpoint too high • Dehumidification PID loop is not properly tuned • Return air humidity does not reflect actual room condition 	<ul style="list-style-type: none"> • Reduce outside air infiltration. • Install vapor barrier materials on floor, walls, and ceiling as needed. • Check and adjust humidification and dehumidification setpoints. • Reduce humidifier sensitivity % setpoint. • Tune the PID loop for accurate dehumidification operation. • Check for short cycling of cold supply air. • Check air distribution for deficiencies. • Consider using remote sensor control. Note: Be certain to purchase the correct temperature and humidity probe. Check when ordering that your equipment is compatible.
Module powered but will not operate	<ul style="list-style-type: none"> • System is off • Remote shutdown or input contact is active • System is in alarm • System is idle (in group mode) 	<ul style="list-style-type: none"> • Turn the System on. • Check input contact configuration settings. • Check front panel display for active system alarms. • Check group mode configuration settings.
Reheat elements inoperative	<ul style="list-style-type: none"> • Reheat mode disabled • Reheat setpoint too low • Thermal cut out switch is open • Blown fuse or fuses • SCR controller malfunction 	<ul style="list-style-type: none"> • Enable reheat mode. • Raise reheat setpoint. • Reset switch and check for proper airflow across heater. • Check for shorted wiring, excessive current draw, and proper input voltage. Replace the fuse or fuses with the specified type. • Verify operation of SCR controller.

Problem	Possible Cause	Corrective Action
Suction pressure too low	<ul style="list-style-type: none"> • Dirty or blocked evaporator coil • Dirty or blocked air filters • Low airflow • Low return air temperature 	<ul style="list-style-type: none"> • Clean evaporator coil. • Check filters and replace as needed. • Check for correct airflow setting. • Verify the return air temperature is not below 20°C (68°F). • Check for short cycling of cold supply air. • Check subcooling and ensure it is at least 10-15°F. Repair leak and recharge system • Check filter drier for excessive pressure drop. • Check for proper superheat and TXV operation.
System short of capacity	<ul style="list-style-type: none"> • Low refrigerant charge • Liquid line filter drier is blocked • High evaporator superheat • Insufficient air quantity across the evaporator coil • Excessive outside air infiltration • Lack of proper room vapor barrier 	<ul style="list-style-type: none"> • Check subcooling and ensure it is at least 10-15°F. Repair leak and recharge system. • Check filter drier for excessive pressure drop. • Check for proper superheat and TXV operation. • Check for correct airflow and clean filters. • Reduce outside air infiltration. • Install vapor barrier materials on floor, walls, and ceiling as needed.
Temperature control not tight enough	<ul style="list-style-type: none"> • Excessive outside air infiltration • Lack of proper room vapor barrier • Cool/reheat setpoints not close enough • Reheat PID loop is not properly tuned • Interstage delay is too large • Return air temperature does not reflect actual room condition 	<ul style="list-style-type: none"> • Reduce outside air infiltration. • Install vapor barrier materials on floor, walls, and ceiling as needed. • Check cooling and reheat setpoints and deadbands. • Tune the PID loop for accurate reheat operation. • Reduce the interstage delay to allow quicker response to temperature changes. • Check for short cycling of cold supply air. • Check air distribution for deficiencies. • Consider using remote sensor control. Note: Be certain to purchase the correct temperature and humidity probe. Check when ordering that your equipment is compatible.
Water carryover	<ul style="list-style-type: none"> • Dirt or oil residue on evaporator coil • Insufficient air quantity across the evaporator coil • Excessive airflow across the evaporator coil • Blockage in condensate pan or drain line • Low return air temperature • High return humidity • Excessive outside air infiltration • Lack of proper room vapor barrier 	<ul style="list-style-type: none"> • Clean the evaporator coil. • Check for correct airflow and clean filters. • Reduce airflow to specifications. • Clean condensate pan and drain line. • Verify the return air temperature is not below 20°C (68°F). • Check for short cycling of cold supply air • Lower humidity setpoint. • Check for short cycling of supply air • Reduce outside air infiltration. • Install vapor barrier materials on floor, walls, and ceiling as needed.

Warranty

One-Year Factory Warranty

The limited warranty provided by American Power Conversion (APC®) in this Statement of Limited Factory Warranty applies only to products you purchase for your commercial or industrial use in the ordinary course of your business.

Terms of warranty

American Power Conversion warrants its products to be free from defects in materials and workmanship for a period of one year from the date of purchase. The obligation of APC under this warranty is limited to repairing or replacing, at its sole discretion, any such defective products. This warranty does not apply to equipment that has been damaged by accident, negligence or misapplication or has been altered or modified in any way. Repair or replacement of a defective product or part thereof does not extend the original warranty period. Any parts furnished under this warranty may be new or factory-remanufactured.

Non-transferable warranty

This warranty extends only to the original purchaser who must have properly registered the product. The product may be registered at the APC Web site, www.apc.com.

Exclusions

APC shall not be liable under the warranty if its testing and examination disclose that the alleged defect in the product does not exist or was caused by end user's or any third person's misuse, negligence, improper installation or testing. Further, APC shall not be liable under the warranty for unauthorized attempts to repair or modify wrong or inadequate electrical voltage or connection, inappropriate on-site operation conditions, corrosive atmosphere, repair, installation, start-up by non-APC designated personnel, a change in location or operating use, exposure to the elements, Acts of God, fire, theft, or installation contrary to APC recommendations or specifications or in any event if the APC serial number has been altered, defaced, or removed, or any other cause beyond the range of the intended use.

THERE ARE NO WARRANTIES, EXPRESS OR IMPLIED, BY OPERATION OF LAW OR OTHERWISE, OF PRODUCTS SOLD, SERVICED OR FURNISHED UNDER THIS AGREEMENT OR IN CONNECTION HEREWITH. APC DISCLAIMS ALL IMPLIED WARRANTIES OF MERCHANTABILITY, SATISFACTION AND FITNESS FOR A PARTICULAR PURPOSE. APC EXPRESS WARRANTIES WILL NOT BE ENLARGED, DIMINISHED, OR AFFECTED BY AND NO OBLIGATION OR LIABILITY WILL ARISE OUT OF, APC RENDERING OF TECHNICAL OR OTHER ADVICE OR SERVICE IN CONNECTION WITH THE PRODUCTS. THE FOREGOING WARRANTIES AND REMEDIES ARE EXCLUSIVE AND IN LIEU OF ALL OTHER WARRANTIES AND REMEDIES. THE WARRANTIES SET FORTH ABOVE CONSTITUTE APC'S SOLE LIABILITY AND PURCHASER'S EXCLUSIVE REMEDY FOR ANY BREACH OF SUCH WARRANTIES. APC WARRANTIES EXTEND ONLY TO PURCHASER AND ARE NOT EXTENDED TO ANY THIRD PARTIES.

IN NO EVENT SHALL APC, ITS OFFICERS, DIRECTORS, AFFILIATES OR EMPLOYEES BE LIABLE FOR ANY FORM OF INDIRECT, SPECIAL, CONSEQUENTIAL OR PUNITIVE DAMAGES, ARISING OUT OF THE USE, SERVICE OR INSTALLATION, OF THE PRODUCTS, WHETHER SUCH DAMAGES ARISE IN CONTRACT OR TORT, IRRESPECTIVE OF FAULT, NEGLIGENCE OR STRICT LIABILITY OR WHETHER APC HAS BEEN ADVISED IN ADVANCE OF THE POSSIBILITY OF SUCH DAMAGES. SPECIFICALLY, APC IS NOT LIABLE FOR ANY COSTS, SUCH AS LOST PROFITS OR REVENUE, LOSS OF EQUIPMENT, LOSS OF USE OF EQUIPMENT, LOSS OF SOFTWARE, LOSS OF DATA, COSTS OF SUBSTITUENTS, CLAIMS BY THIRD PARTIES, OR OTHERWISE.

NO SALESMAN, EMPLOYEE OR AGENT OF APC IS AUTHORIZED TO ADD TO OR VARY THE TERMS OF THIS WARRANTY. WARRANTY TERMS MAY BE MODIFIED, IF AT ALL, ONLY IN WRITING SIGNED BY AN APC OFFICER AND LEGAL DEPARTMENT.

Warranty claims

Customers with warranty claims issues may access the APC customer support network through the Support page of the APC Web site, www.apc.com/support. Select your country from the country selection pull-down menu at the top of the Web page. Select the Support tab to obtain contact information for customer support in your region.

Warranty Procedures

Claims

To obtain service under the warranty, contact APC Customer Support (see the back cover of this manual for contact information). You will need the model number of the Product, the serial number, and the date purchased. A technician will also ask you to describe the problem. If it is determined that the Product will need to be returned to APC, you must obtain a returned material authorization (RMA) number from APC Customer Support. Products that must be returned must have the RMA number marked on the outside of the package and must be returned with transportation charges prepaid. If it is determined by APC Customer Support that on-site repair of the Product is allowed, APC will arrange to have APC authorized service personnel dispatched to the Product location for repair or replacement, at the discretion of APC.

Parts

- APC warrants the parts of their systems for 1 year from the date of commissioning or 18 months from the ship date. This warranty only covers the cost of the part and not the labor for installation.
- Calls for warranty parts requests need to have specific unit information (serial number, model number, job number) to allow proper identification and processing of the warranty part transaction.
- A purchase order may be required to issue any warranty parts. An invoice will be sent once the parts are shipped to the field. You have 30 days to return the defective parts to APC. After 30 days, the warranty invoice will be outstanding, and payment of the invoice will be expected in full.
- Return authorization documentation will be sent with the replacement part. This documentation must be sent back with the defective part to APC for proper identification of the warranty return. Mark the warranty return number on the outside of the package.
- After the part has been received at APC, we will determine the status of the credit based on the findings of the returned part. Parts that are damaged from lack of maintenance, misapplication, improper installation, shipping damage, or acts of man/nature will not be covered under the parts warranty.
- Any warranty parts request received before 1:00 PM EST will be shipped same-day standard ground delivery. Any costs associated with Next Day or Airfreight will be the responsibility of the party requesting the part.
- Return freight of warranty parts to APC is the responsibility of the party returning the part.

APC Worldwide Customer Support

Customer support for this or any other APC product is available at no charge in any of the following ways:

- Visit the APC Web site to access documents in the APC Knowledge Base and to submit customer support requests.
 - **www.apc.com** (Corporate Headquarters)
Connect to localized APC Web sites for specific countries, each of which provides customer support information.
 - **www.apc.com/support/**
Global support searching APC Knowledge Base and using e-support.
- Contact an APC Customer Support center by telephone or e-mail.
 - Regional centers

Direct InfraStruXure Customer Support Line	(1)(877)537-0607 (toll free)
APC headquarters U.S., Canada	(1)(800)800-4272 (toll free)
Latin America	(1)(401)789-5735 (USA)
Europe, Middle East, Africa	(353)(91)702000 (Ireland)
Western Europe (inc. Scandinavia)	+800 0272 0272
Japan	(0) 36402-2001
Australia, New Zealand, South Pacific area	(61) (2) 9955 9366 (Australia)

- Local, country-specific centers: go to **www.apc.com/support/contact** for contact information.

Contact the APC representative or other distributor from whom you purchased your APC product for information on how to obtain local customer support.

Entire contents copyright 2007 American Power Conversion Corporation. All rights reserved. Reproduction in whole or in part without permission is prohibited. APC, the APC logo, InfraStruXure, and NetworkAIR are trademarks of American Power Conversion Corporation. All other trademarks, product names, and corporate names are the property of their respective owners and are used for informational purposes only.



990-3127



10/2007